

voltimum

Alejandro Baselga

ELT

SOLUCIONES AVANZADAS DE ILUMINACIÓN CON TECNOLOGÍA LED

1. Parámetros básicos de iluminación
2. Luminaria LED
3. LED
4. Driver
5. CC vs CV
6. Verificación de Luminarias
7. OLED
8. Gestión de la iluminación y Smart Lighting

9. Human Centric
10. Diseño de Luminarias LED
11. Iluminación Retail
12. Iluminación Oficinas
13. Iluminación Industrial
14. Iluminación Deportiva
15. Iluminación Vial
16. Tendencias y Futuro

Aproximadamente el **80%** de la información que recibe el ser humano proviene del sentido de la **vista.**

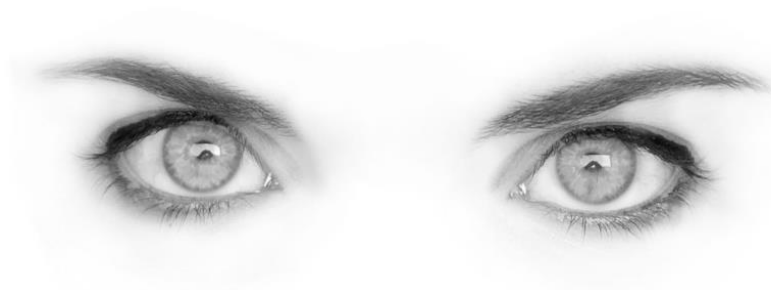

- El **flujo luminoso** es el potencia transmitida en forma de radiación en todas direcciones por una fuente de luz durante una unidad de tiempo.
- Su unidad es el **lumen** (Lm).



INTENSIDAD LUMINOSA

- Se conoce como **intensidad luminosa** al flujo luminoso emitido por unidad de ángulo sólido en una dirección concreta.
- Su unidad de medida es la CANDELA (Cd).



ILUMINANCIA

- La iluminancia es el flujo lumínico que incide sobre una superficie
- La unidad de medida es el **LUX**:

$$1 \text{ lux} = 1 \text{ Lumen/m}^2.$$

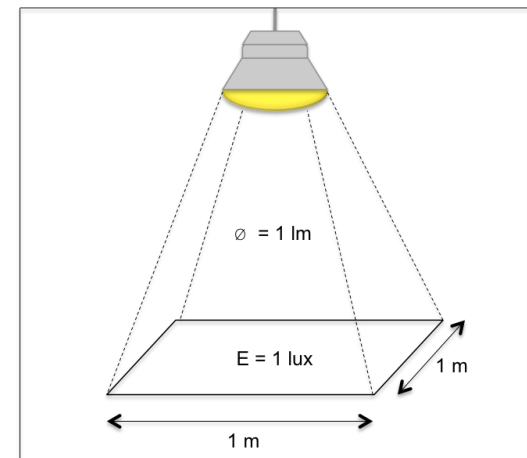

EFICACIA LUMINOSA

- Es el flujo lumínico emitido por cada unidad de potencia eléctrica consumida.
- Se expresa en **Lm/w**

EFICACIA LUMINOSA

- Es el flujo lumínico emitido por cada unidad de potencia eléctrica consumida.
- Se expresa en **Lm/w**



LED



SISTEMA

DIAGRAMA DE CROMATICIDAD

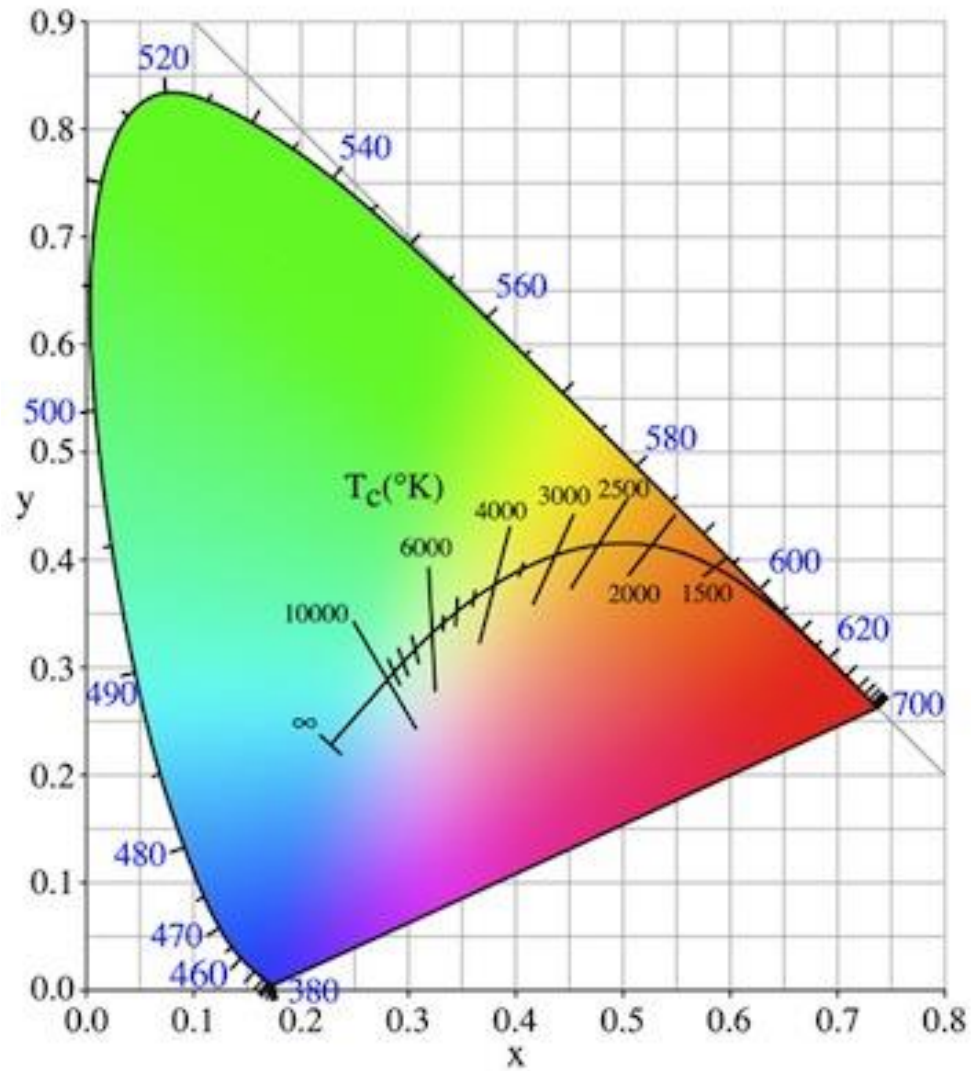

TEMPERATURA DE COLOR

Apariencia de color	Temperatura de color (K)
Cálida	<3.300
Neutro	Entre 3.300 - 5.300
Frío	>5.300

DIAGRAMA DE CROMATICIDAD

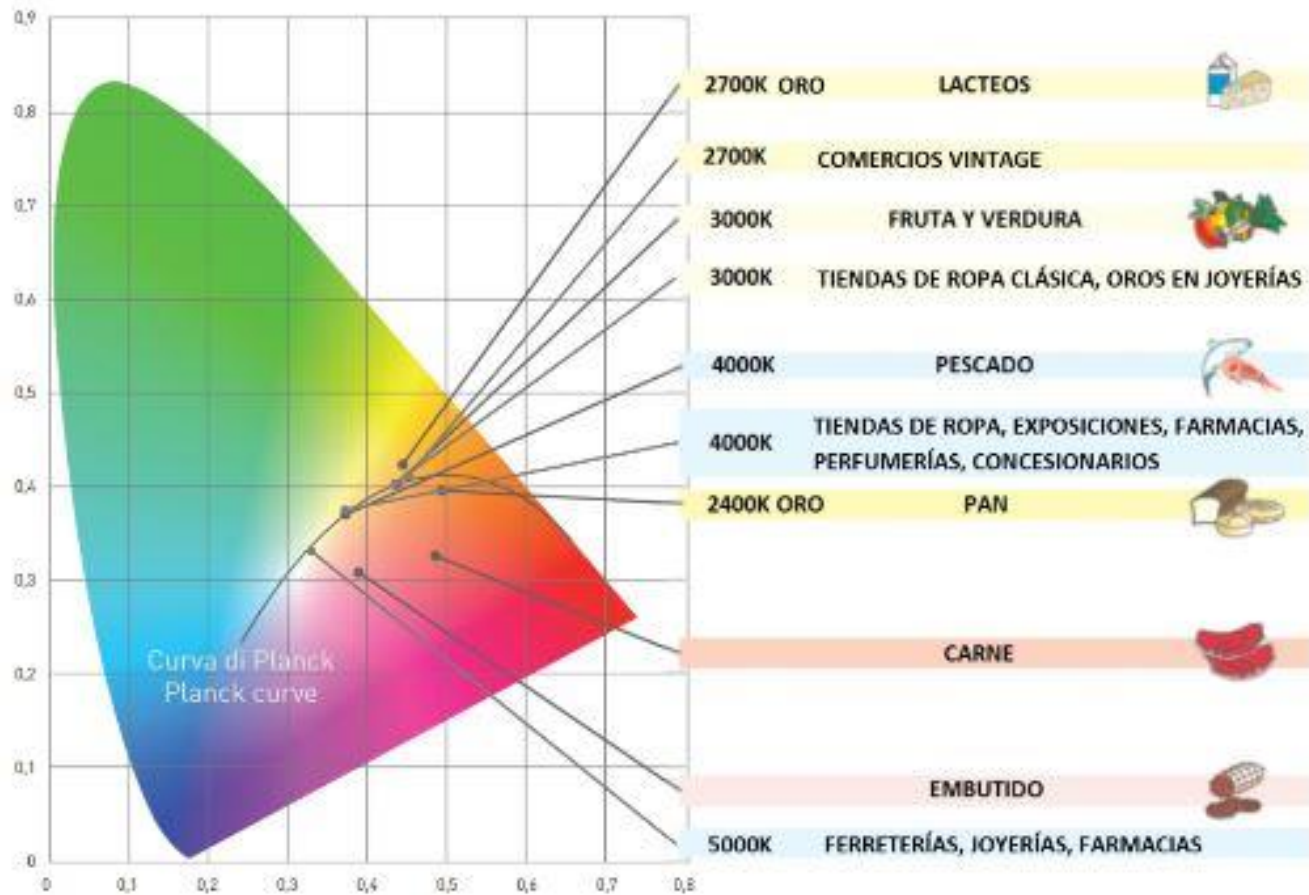

ÍNDICE DE REPRODUCCIÓN CROMÁTICO (IRC)

- El **IRC** es la capacidad de la fuente de luz para reproducir fielmente el color.

Grado	Índice (IRC)	Nivel de reproducción
1A	90 a 100	Excelente
1B	80 a 89	Muy bueno
2A	70 a 79	Bueno
2B	60 a 69	Moderado
3	40 a 59	Regular
4	Inferior a 40	Bajo

ÍNDICE DE REPRODUCCIÓN CROMÁTICO (IRC)

Standard LED CRI Values (82 CRI)

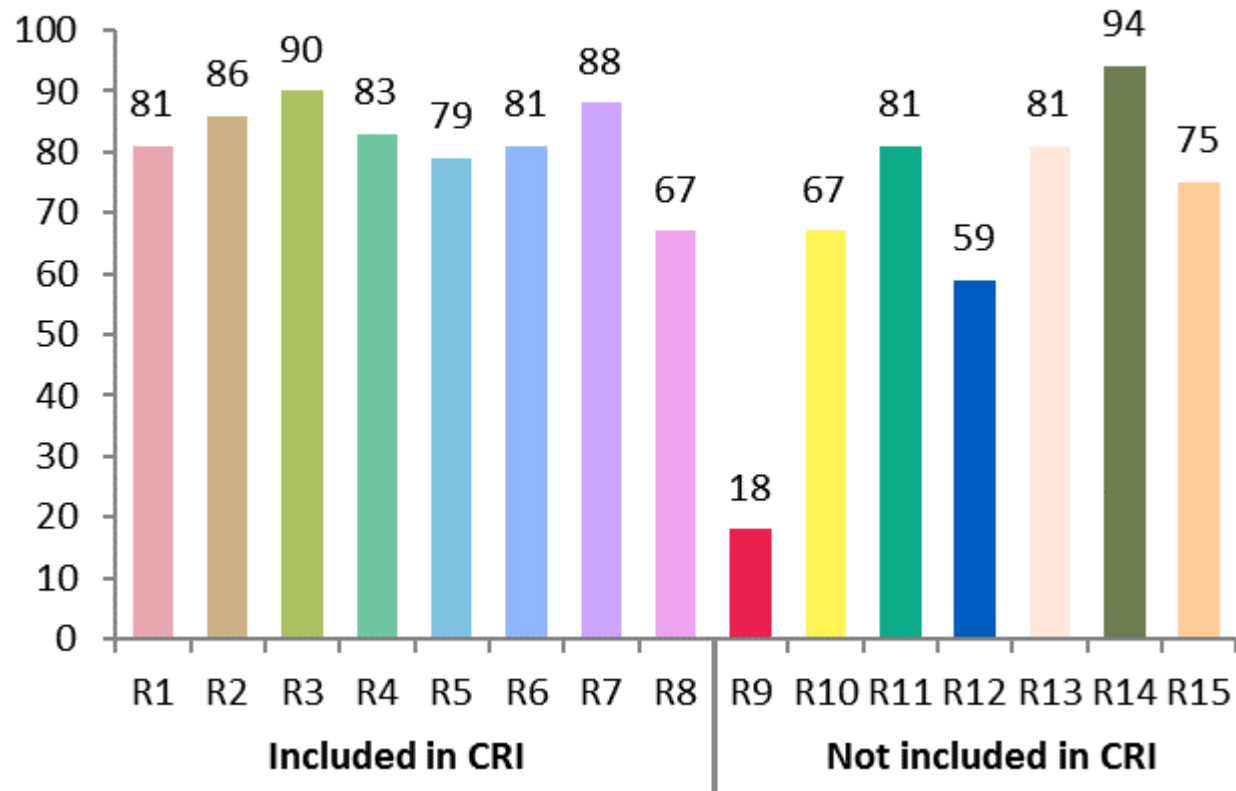

ÍNDICE DE REPRODUCCIÓN CROMÁTICO (IRC)



2700K
CRI 97



2700K
CRI 90



2700K
CRI 80



2700K
CRI 70

TM-30-15

Guía rápida

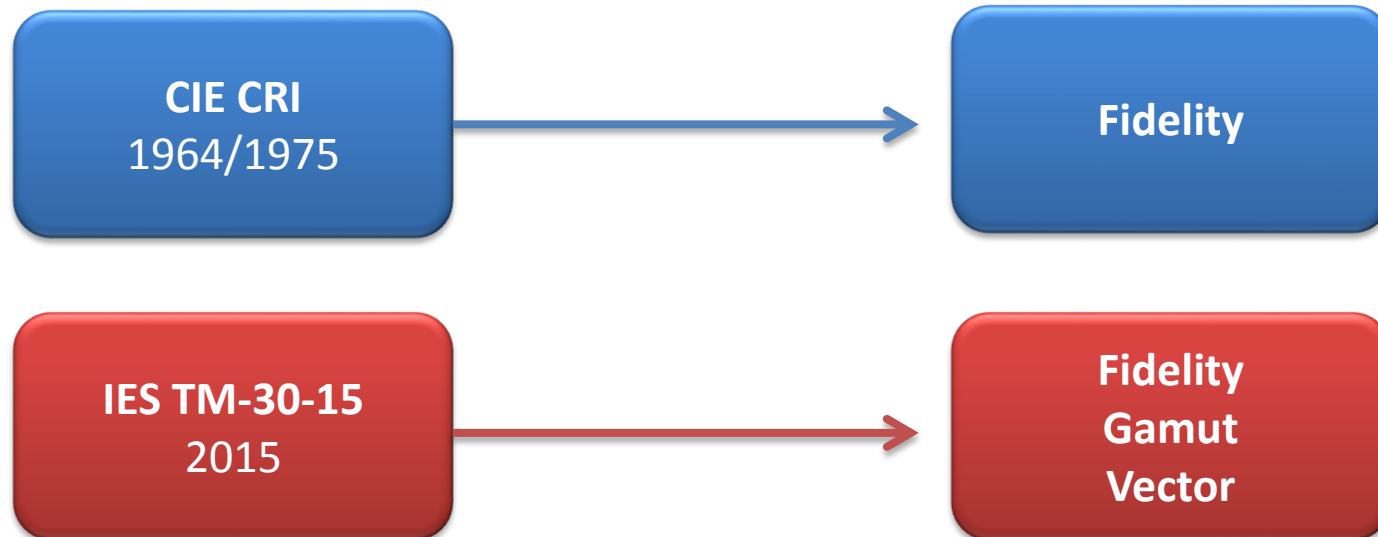

TM-30-15

Guía rápida



International Commission on Illumination
Commission Internationale de l'Eclairage
Internationale Beleuchtungskommission



Illuminating
ENGINEERING SOCIETY

colour fidelity (a_p)



VS

TM-30 evaluates
colour spaces and 99
colour samples



colour gamut (R_g)



desaturated
R_g < 100



original
R_g = 100



saturated
R_g > 100

colour vector

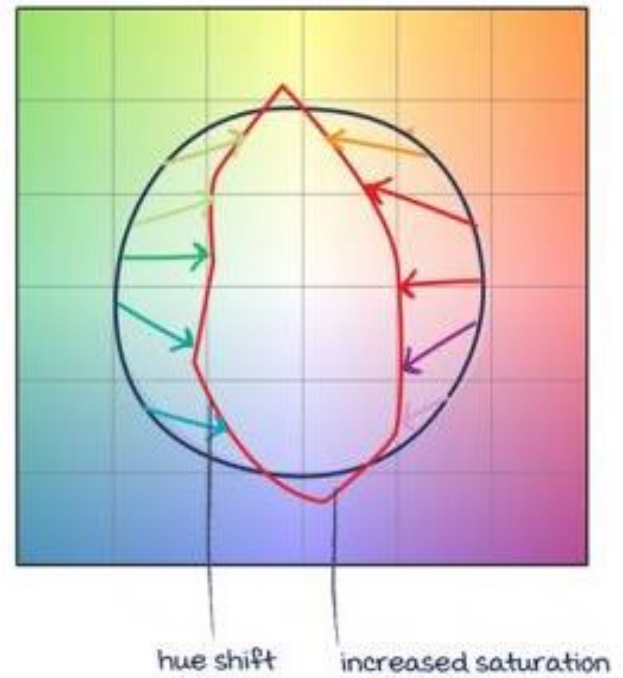
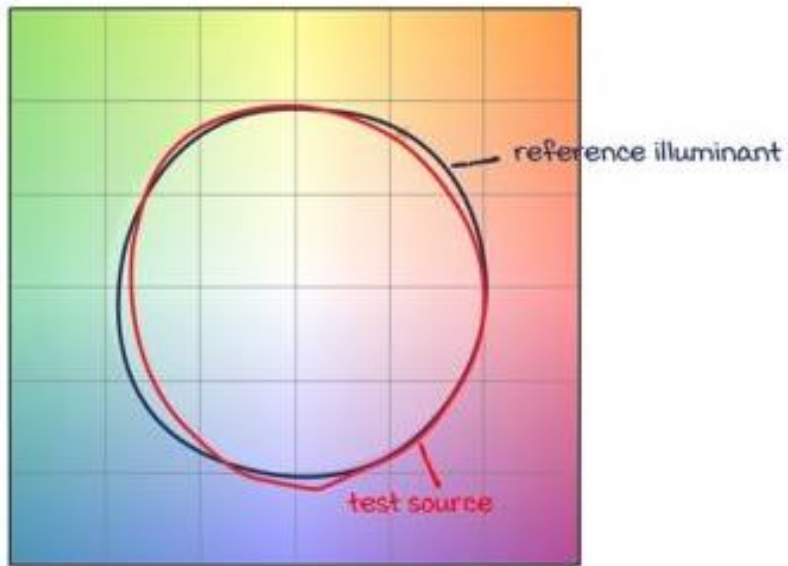

REFLEXIÓN

¿Cuál es más real?

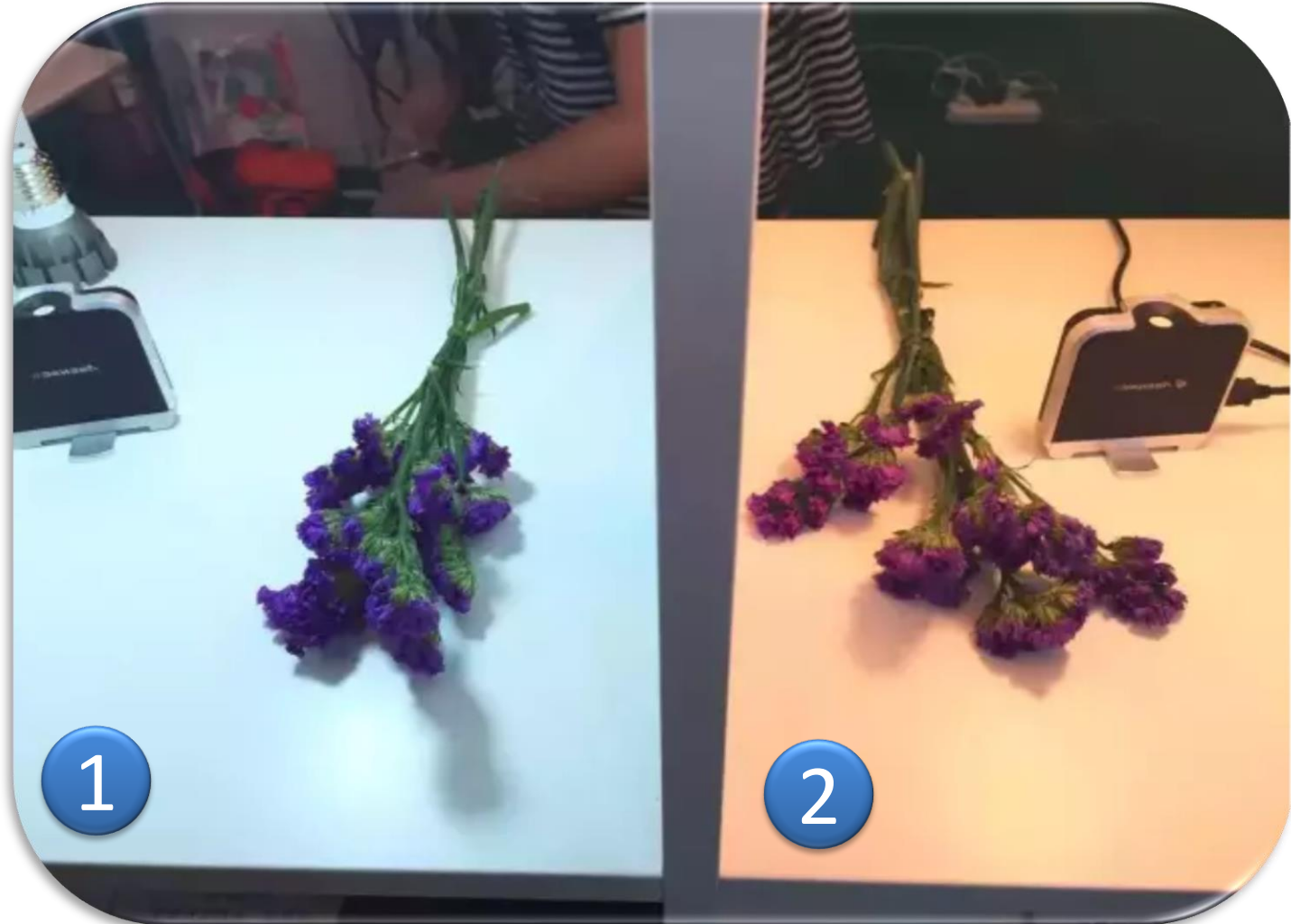

REFLEXIÓN

¿Cuál es más real?

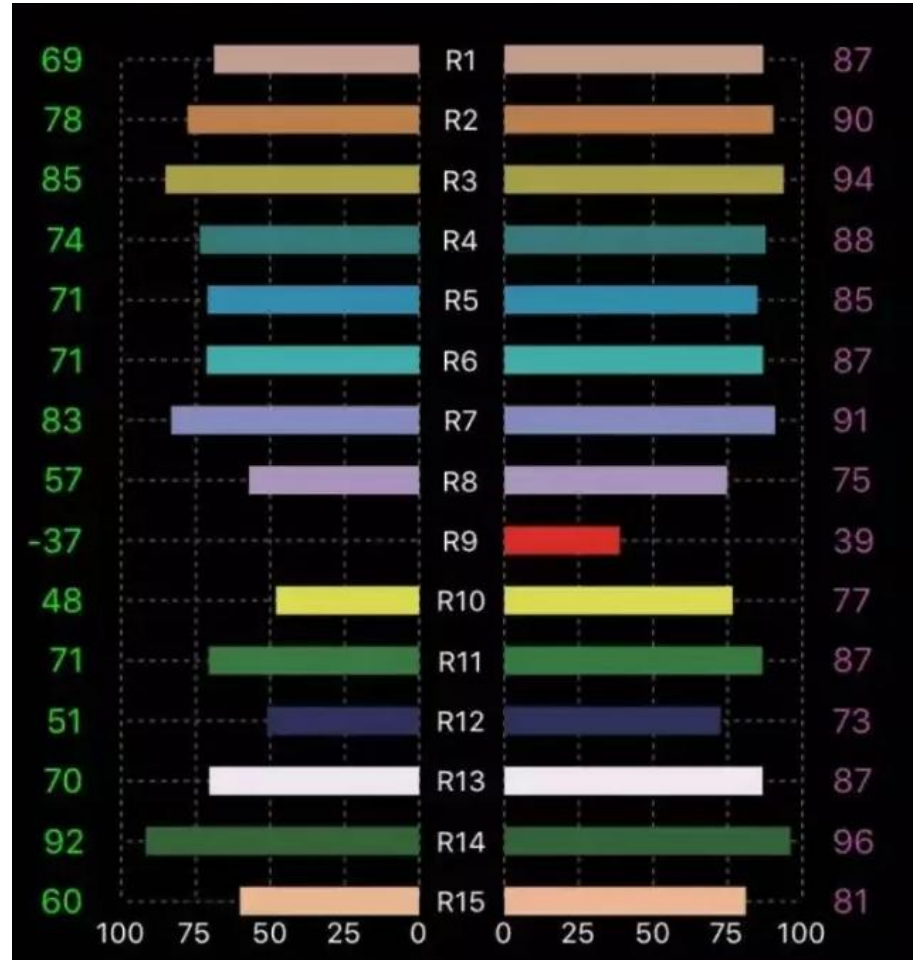

UGR



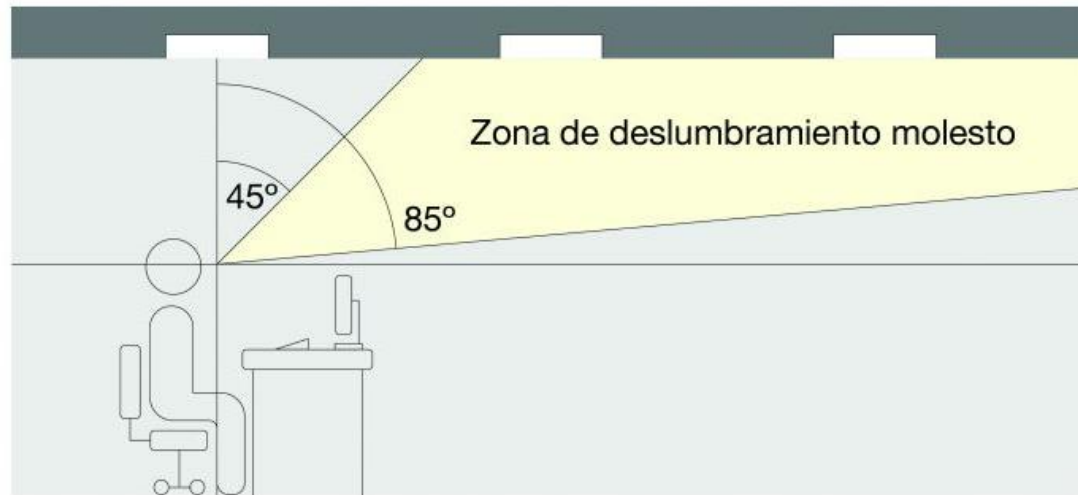

- **UGR:** Índice de deslumbramiento
- Valores: 10 – 30 (10, 13, 16, 19, 22, 25 y 28)
- $UGR = 8 \log(0.25/L_b SL2w/p2)$

UGR

COMMON
UGR 25



Not
Comfortable

COMMON
UGR 22



Just feel it

COMMON
UGR 19



Can live with it

UGR 16



Good

UGR 13



Excellent

UGR OFICINAS

UGR < 25



UGR < 19



UGR

UGR < 25



UGR < 19



UGR

UGR < 25

UGR



GUERRA DE PRECIO €

VIDA ÚTIL NOMINAL

- **L** indica el porcentaje de flujo luminoso que se ha reducido del valor original al cabo de un determinado tiempo.
- **B** representa el porcentaje de módulos que no logran alcanzar el valor L especificado.

- **L70 B30 50.000 h** significa que el 70 % de los módulos LED funcionales después de 50.000 horas queda por encima del 70 % del valor original del flujo luminoso.

VIDA ÚTIL NOMINAL

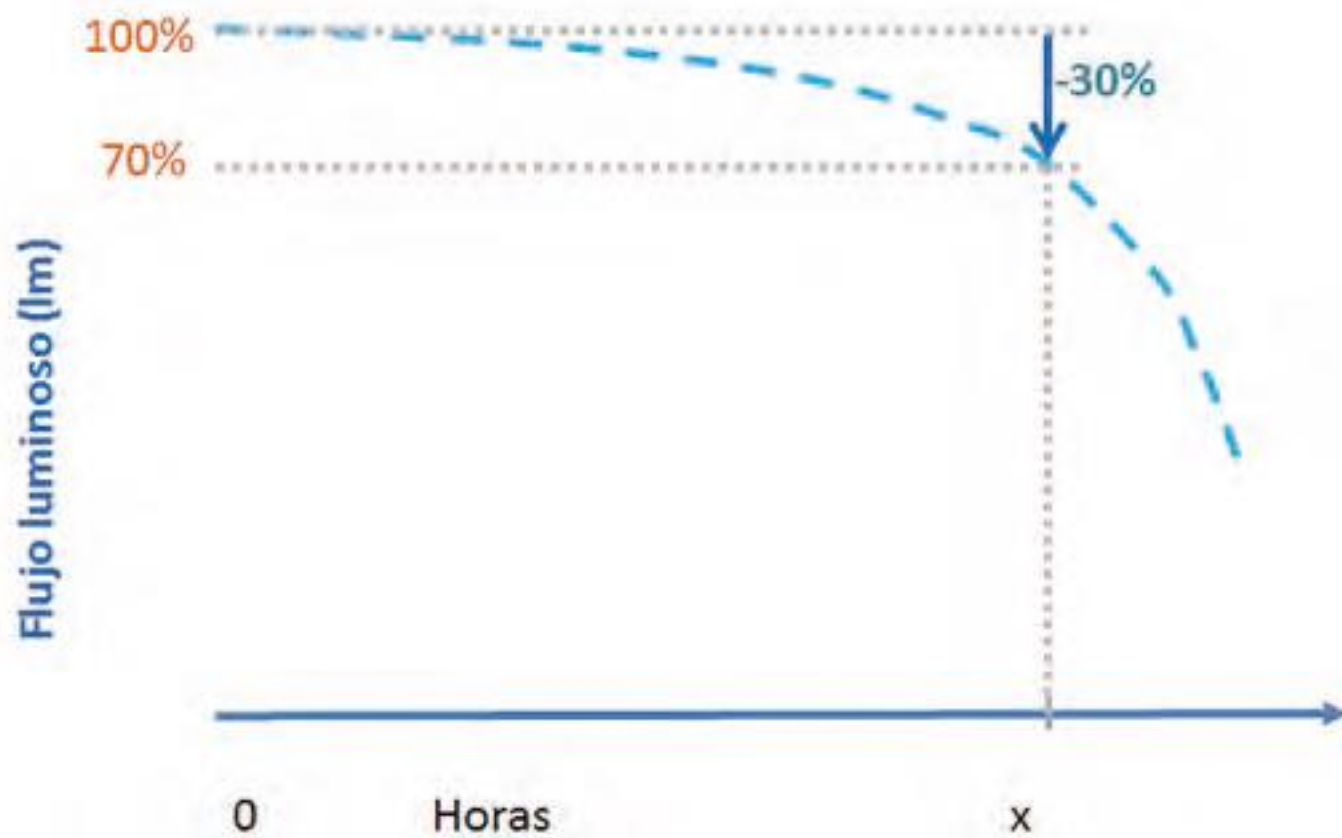

LUMINARIAS LED

50% de las exportaciones
Chinas en iluminación
son para la UE.

4.038 MILL €

40% MERCADO

[1] http://www.ledinside.com/ledinside/2012/09/20/02/technological_barriers_beside_china_led_lighting/

[2] http://www.researchandmarkets.com/research/4bq2fu/led_lighting

REFLEXIÓN

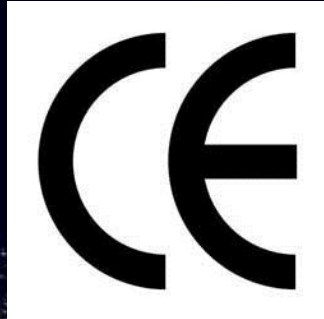

de
Chi
son para la UE.

4.038 MILL €
40% MERCADO

[1] http://www.leidrade.com/files/2012/01/01/Technical_barriers_besoge_china.pdf

[2] http://www.researchandmarkets.com/research/4bq1fud_lighting

REFLEXIÓN

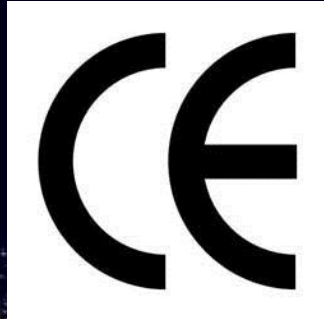

de
Chi
son para la UE.



4.038 MILL €

40% MERCADO

[1] http://www.leidrade.com/files/2012/01/01/technical_barriers_besoge_china.pdf

[2] http://www.researchandmarkets.com/research/abg21u/led_lighting

LUMINARIAS LED

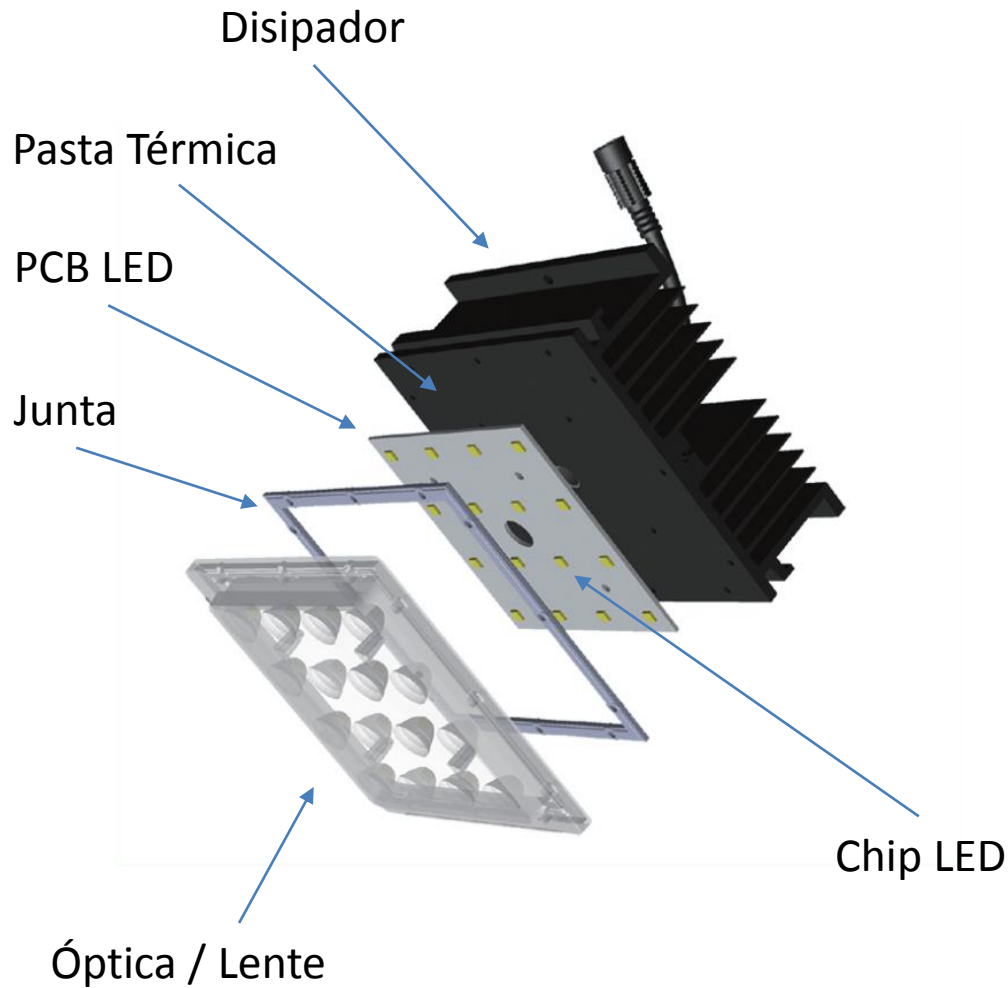

Driver



¿QUE ES LED?

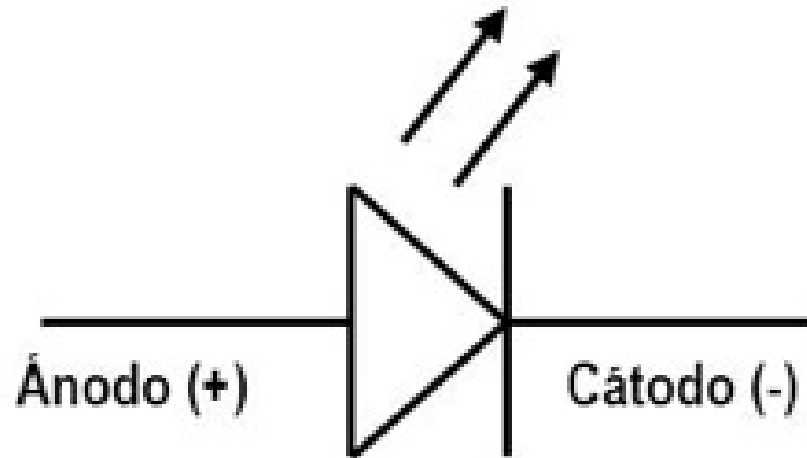

¿QUE ES LED?

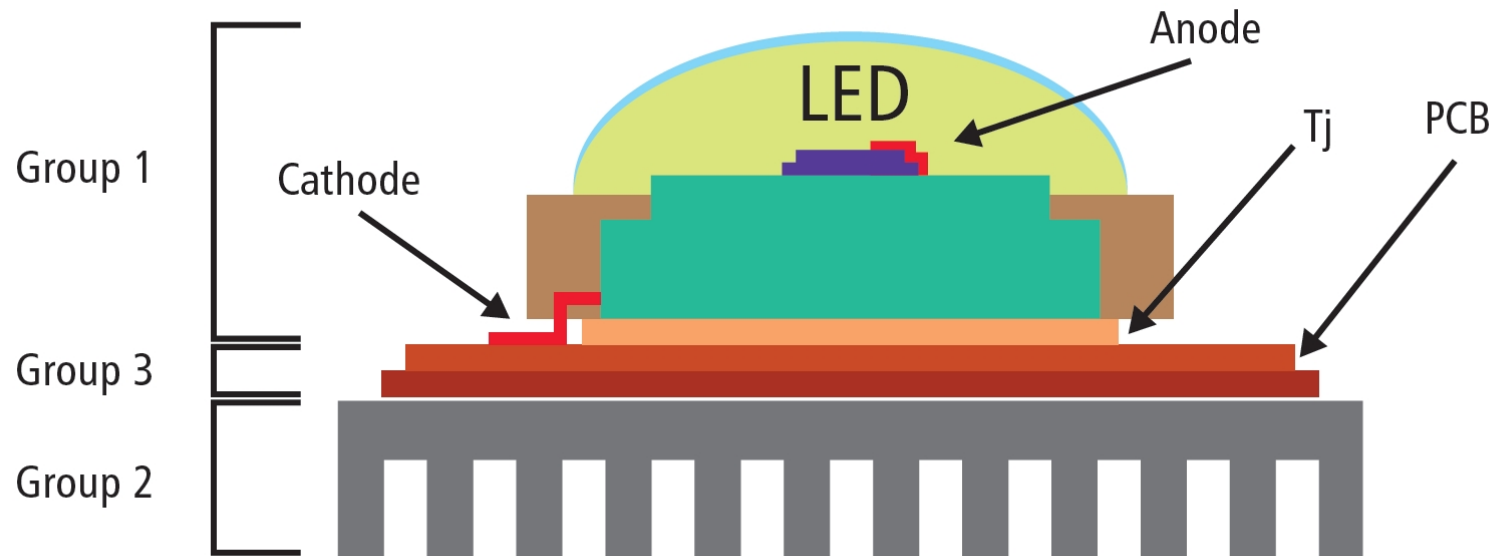

¿QUE ES LED?

InGaN :

- Azul Real
- Azul
- Cian
- Verde

¿Blanco?

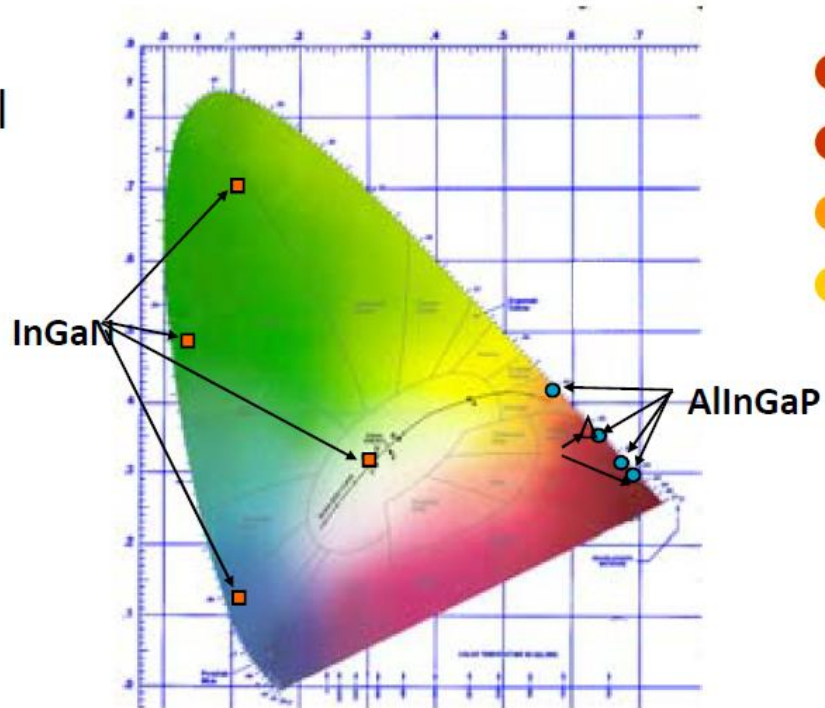

TS AlInGaP :

- Rojo
- Rojo-Naranja
- Naranja
- Ámbar

¿QUE ES LED?

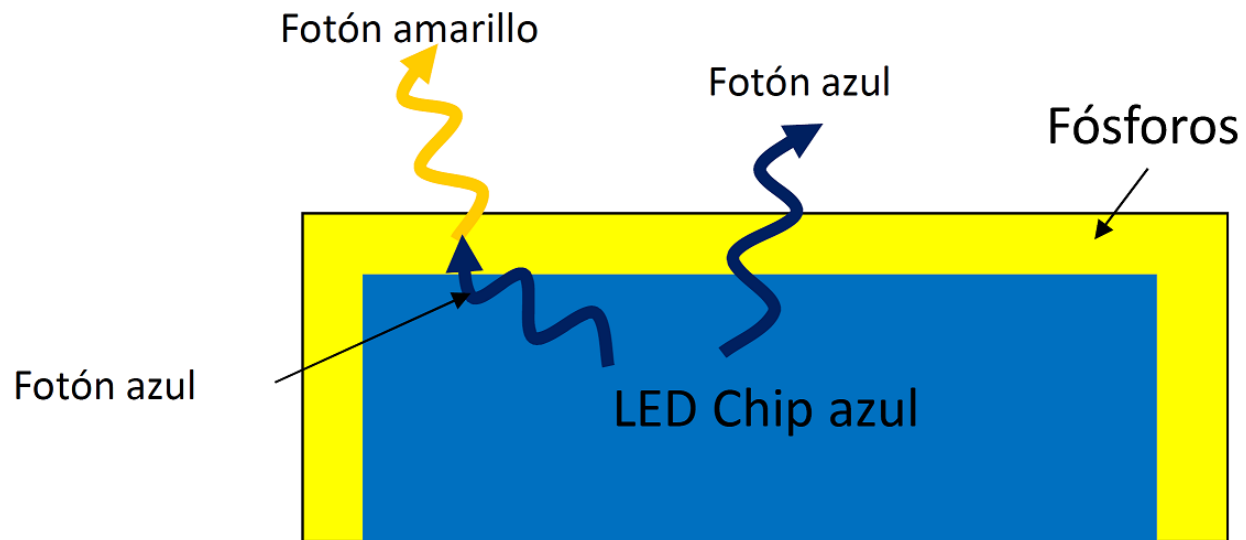

VENTAJAS ILUMINACIÓN LED

- Tamaño reducido
- Alta resistencia contra golpes
- Larga duración: entre 50.000 y 100.000 horas
- Bajo consumo
- Alta eficiencia
- No radiación UV/IR
- Efectividad a bajas temperaturas: hasta de -30° C.

TIPOS DE LED

SMD



COB



TIPOS DE LED

SMD



COB



~~MICROLED~~

PROCESO BINNING

Elección de un LED – Binning

- Bin de Tensión Directa
- Bin de Color
- Bin de Flujo Luminoso o brillo

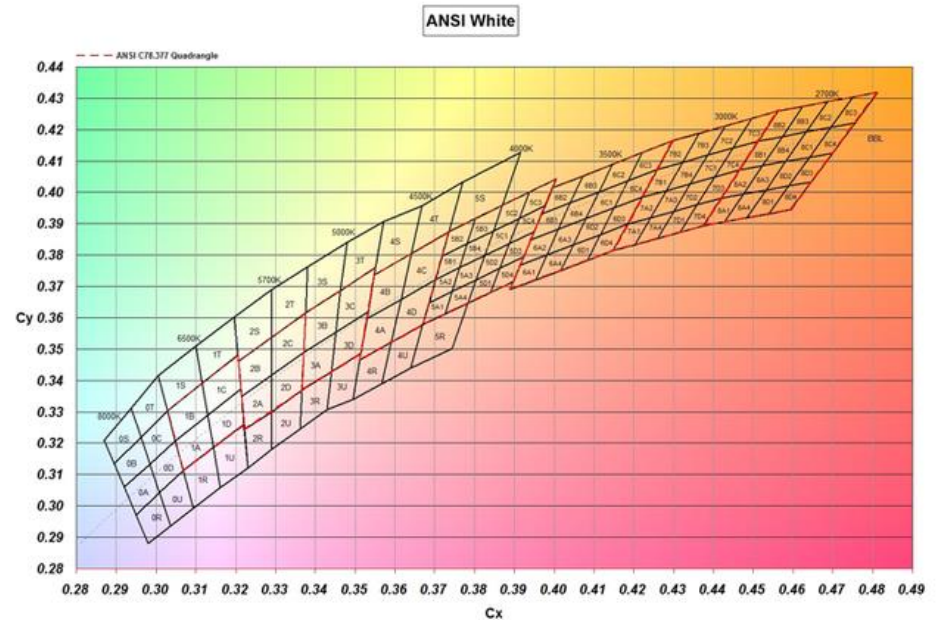

ELIPSES DE MACADAM – SDCM

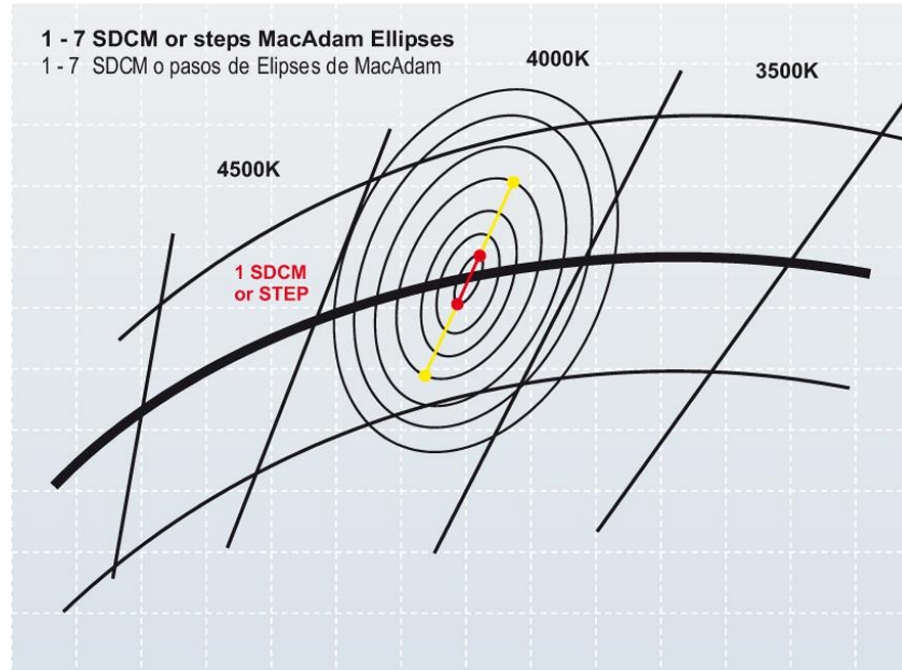

1 SDCM: No existen diferencias de color.

2–4 SDCM: Apenas existe una diferencia visible.

5 o más SDCM: Es fácilmente perceptible.

EVOLUCIÓN LED

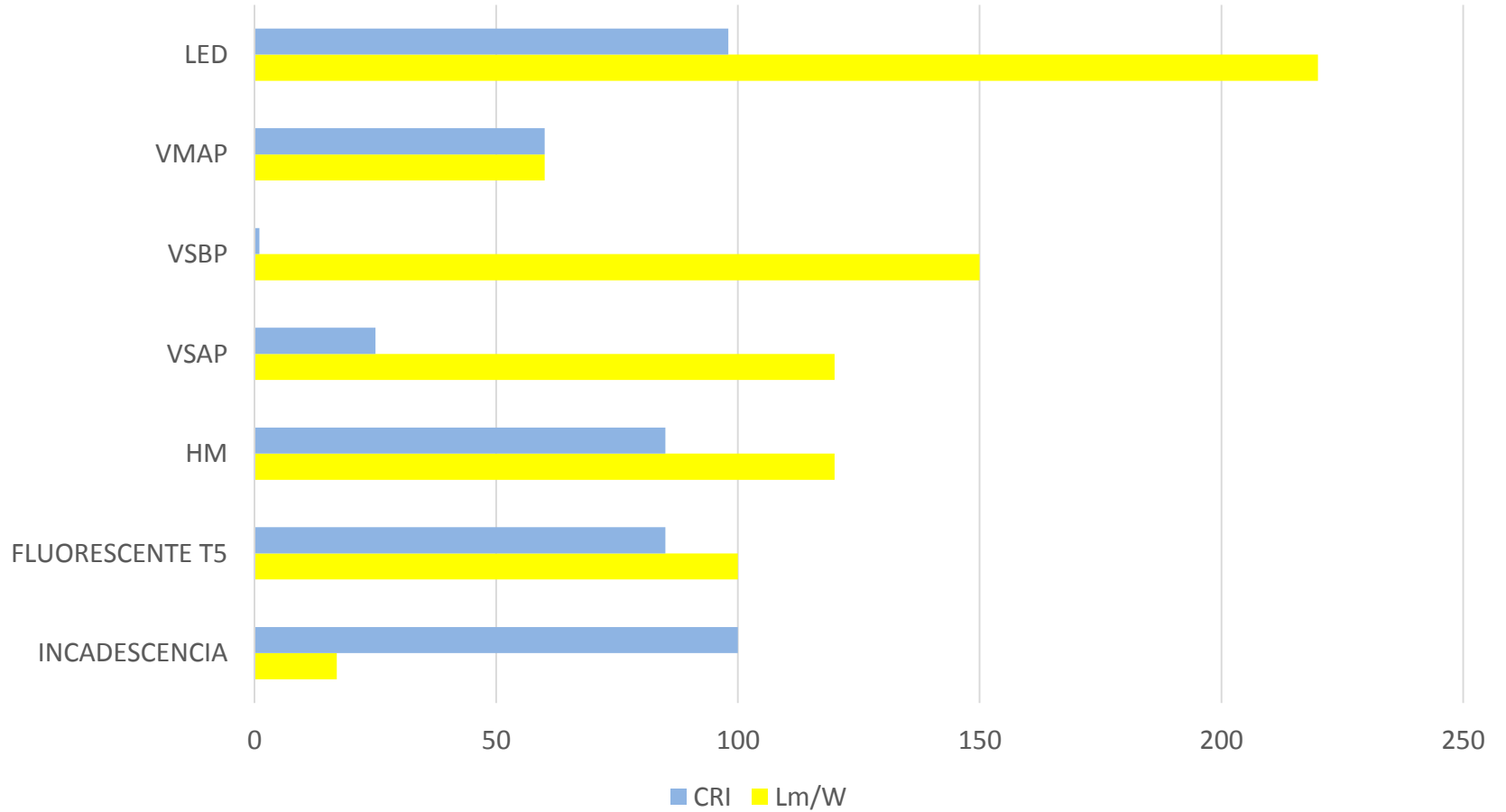

EVOLUCIÓN LED

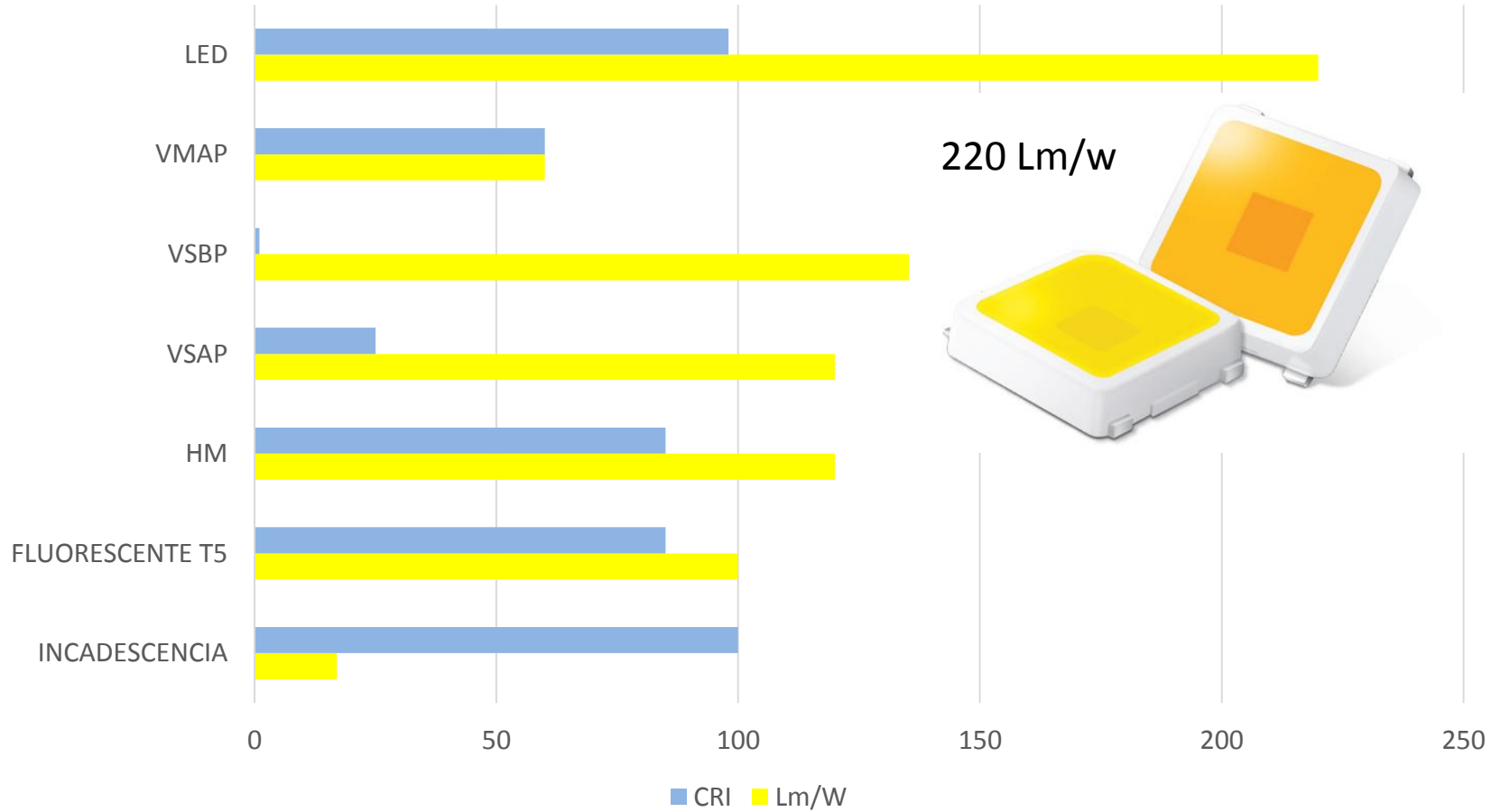

FABRICANTES CHIP LED

	NOMBRE	2015 (mln \$)
1	NICHIA	2,290
2	OSRAM Opto	1,169
3	Lumileds	1,140
4	Samsung LED	835
5	Seoul Semi	772
6	Everlight	648
7	CREE	578
8	LG Innotek	523
9	MLS	507
10	Liteon	281



- **Zhaga** es un consorcio global de empresas
- Permitir la intercambiabilidad de módulos LED y de sus equipos de control.
- Proporciona plataformas estables de diseño para los módulos de LED, con el propósito de garantizar esta intercambiabilidad de emisores de luz LED.

¿Son los LED realmente peligrosos?

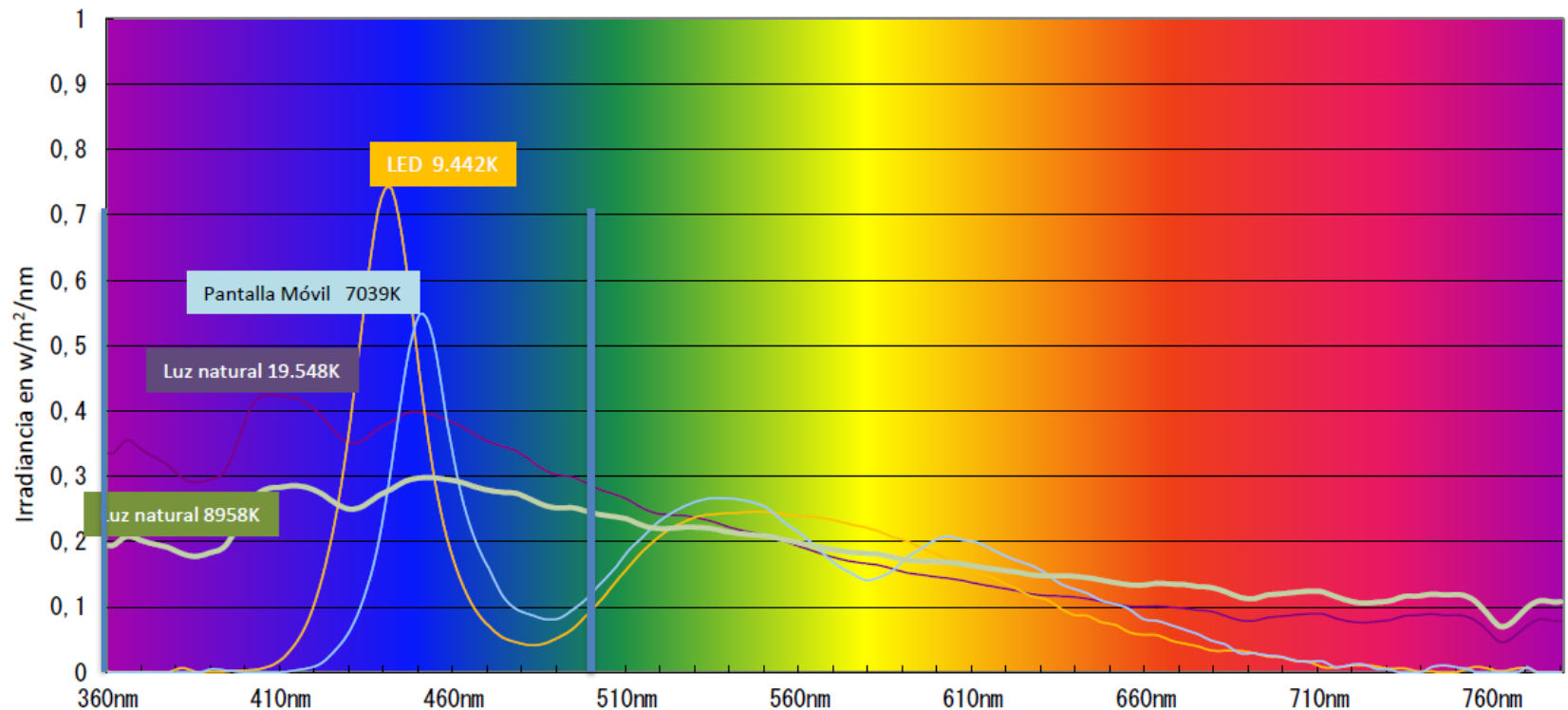

Un LED muy muy frío de 9.442K: luminaria ext. 76lux; $41\%(360nm-500nm)/(360nm-780nm)$

Pantalla móvil de 7039K; Pantalla móvil 46lux; $33\%(360nm-500nm)/(360nm-780nm)$

Luz natural 19.548K; Sombra del edificio vertical al cielo 3937lux; $57\%(360nm-500nm)/(360nm-780nm)$

Luz natural 8958K; Sombra del edificio posición ojo 9839lux; $45\%(360nm-500nm)/(360nm-780nm)$

¿Son los LED realmente peligrosos?

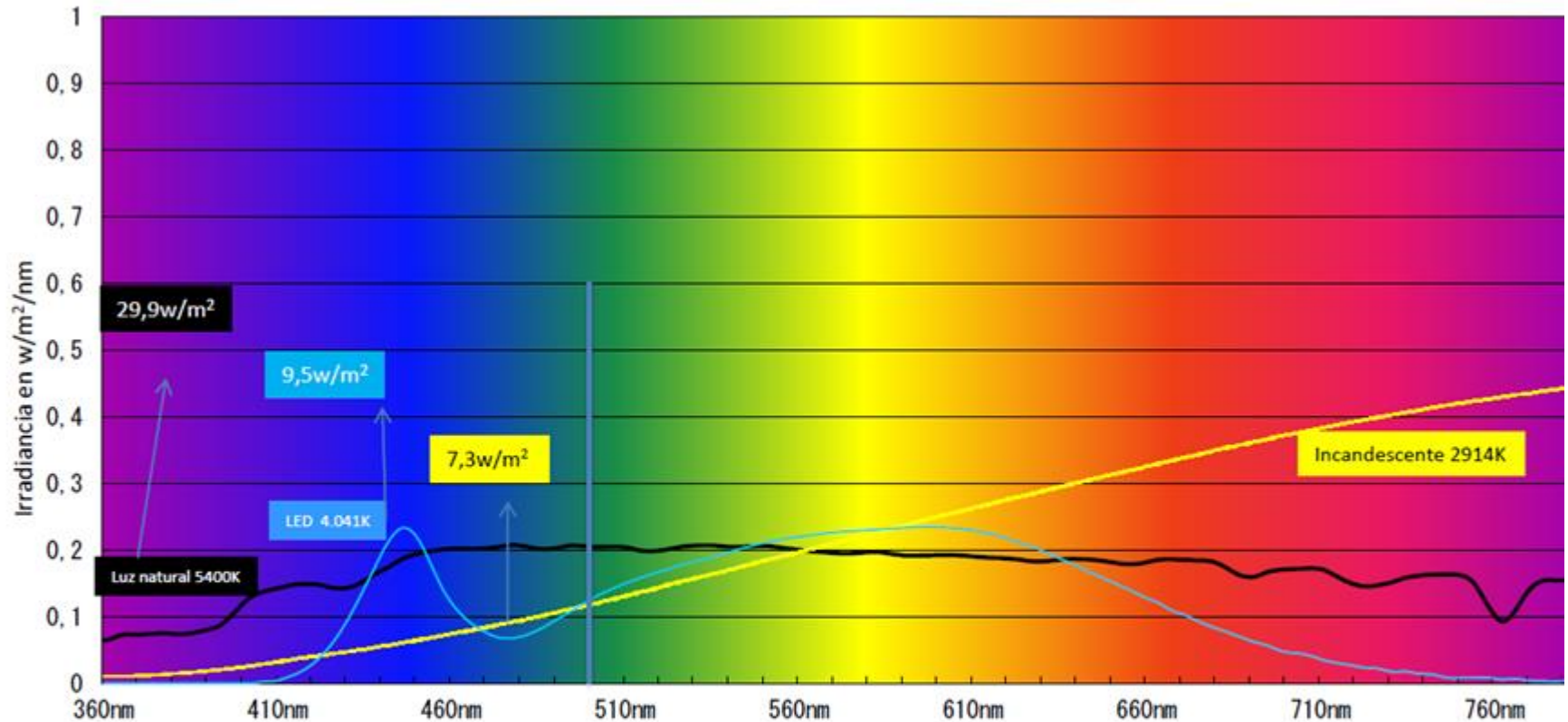

Luz natural 5400K: 29%

LED 4041K: 21%

Incandescente 2914K: 8%

REFLEXIÓN



REFLEXIÓN

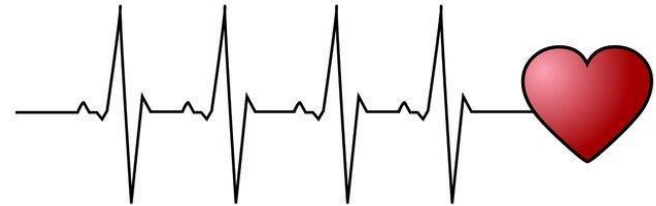

DRIVER

Corriente Constante



Tensión Constante



DRIVER

Corriente Constante CC

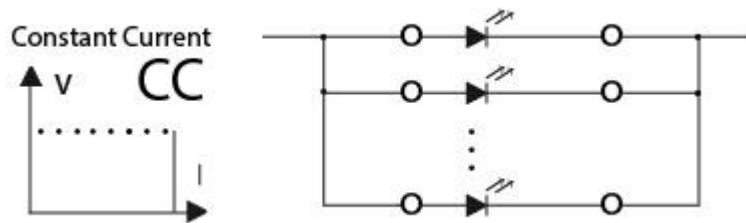

350mA 500mA 700mA

Tensión Constante TC

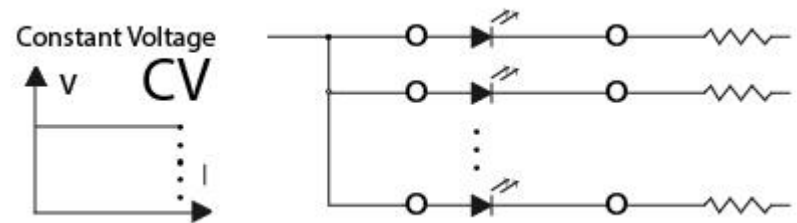

12VDC 24VDC

DRIVER CC

LO NECESARIO

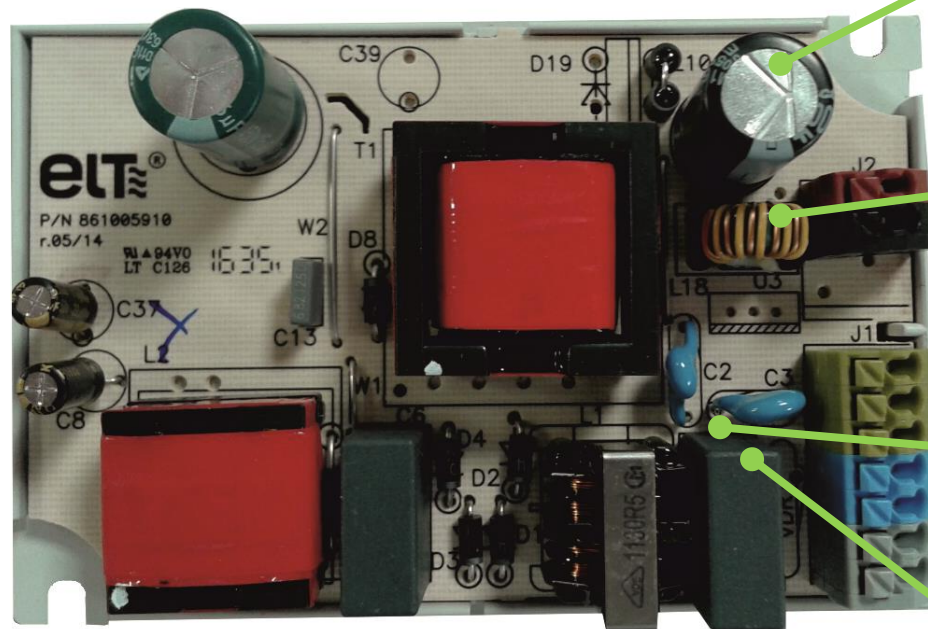

ROBUSTO

CALIDAD
DE LA LUZ

BUEN PFC,
THD, η ..

ACORDE A
NORMAS

DRIVER CC

LO DESEABLE

COMPACTO

MONITORIZACIÓN
TEMPERATURA
MÓDULO LED

CONTROL POR
MICROPROCESADOR

1...10V

¿€?

PROTECCIÓN
CONTRA
SOBRETENSIONES

DALI

PROTECCIÓN
CONTRA RAYOS

PROGRAMABLE

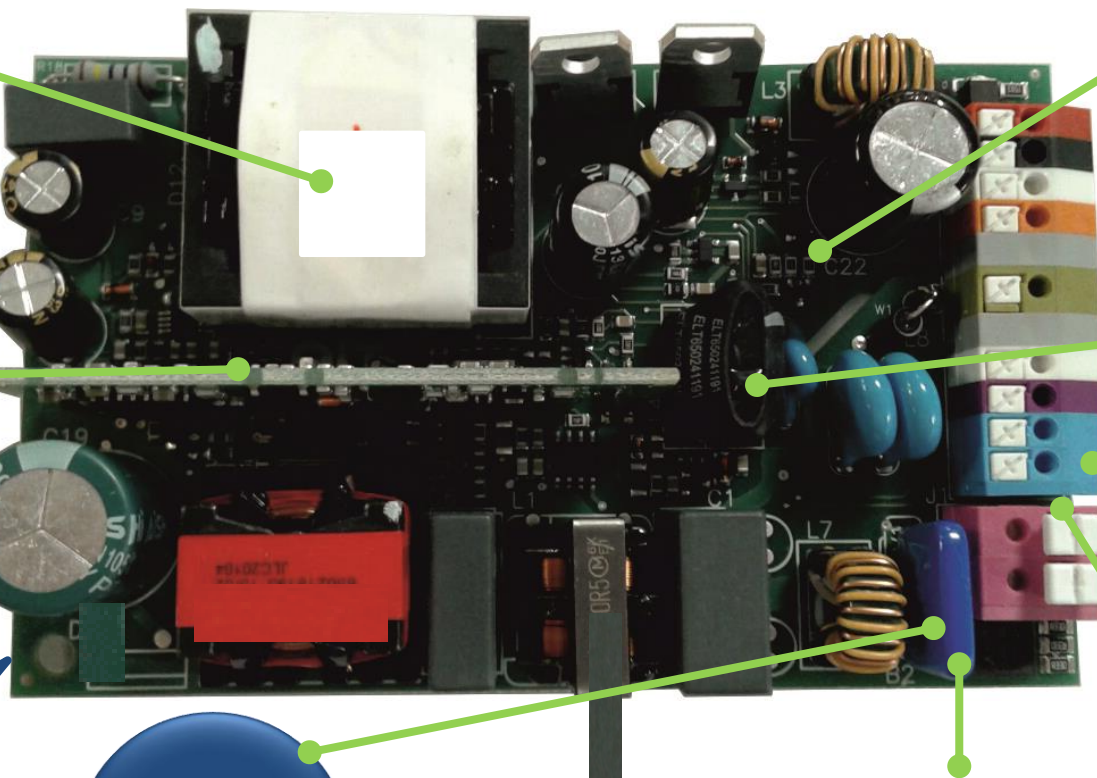

DRIVER CC

LO NECESARIO

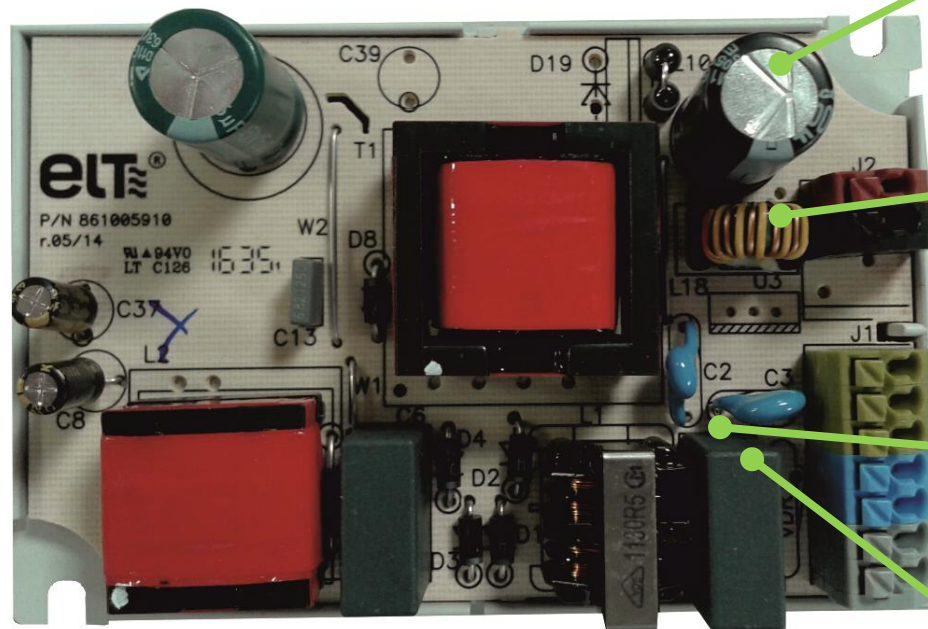

ROBUSTO

CALIDAD DE LA LUZ

BUEN PFC, THD, η ..

ACORDE A NORMAS

DRIVER CC

LO NECESARIO

NO SE PUEDE AHORRAR COSTE

ALTA CALIDAD
DE LA LUZ

BUEN PFC,
THD, η ..



DRIVER VC



NOTE

1. All parameters NOT specially mentioned are measured at 230VAC(115VAC for) input, rated load and 25°C of ambient temperature.
2. Ripple & noise are measured at 20MHz of bandwidth by using a 12" twisted pair-wire terminated with a 0.1uf & 47uf parallel capacitor.
3. Tolerance : includes set up tolerance, line regulation and load regulation.
4. Derating may be needed under low input voltage. Please check the static characteristics for more details.
5. The power supply is considered as a component that will be operated in combination with final equipment. Since EMC performance will be affected by the complete installation, the final equipment manufacturers must re-qualify EMC Directive on the complete installation again.
6. Length of set up time is measured at first cold start. Turning ON/OFF the power supply may lead to increase of the set up time.
7. The unit might not be suitable for lighting applications in EU countries. Please check with your local authorities for the possible use of the unit.
8. Suitable for indoor use or outdoor use without direct sunlight exposure.

■ Applications

- Industrial automation machinery
- Industrial control system
- Mechanical and electrical equipment
- Electronic instruments, equipments or apparatus



DRIVER VC



**NO SE PUEDE AHORRAR COSTE
NO CUMPLE CE PARA ILUMINACIÓN**

NOTE

1. All parameters NOT specially mentioned are measured at 25°C of ambient temperature.
2. Ripple & noise are measured at 20MHz with a 0.1uf & 47uf parallel capacitor.
3. Tolerance : includes set up tolerance.
4. Derating may be needed under certain conditions. Please refer to the datasheet for more details.
5. The power supply is considered as a Class II power supply. It should be used with final equipment. Since EMC performance will be affected by the complete installation, please refer to the EMC test report for more details.
6. Length of set up time may vary according to the power supply may lead to increase of the set up time.
7. The unit must be used in accordance with the CE mark. Please check with your local authorities for the possible use of the unit.
8. Suitable for use in the following areas:
 - 1. Industrial machinery
 - 2. Control system
 - 3. Mechanical and electrical equipment
 - 4. Electronic instruments, equipments or apparatus



DISTRIBUCION FALLOS LUMINARIA LED

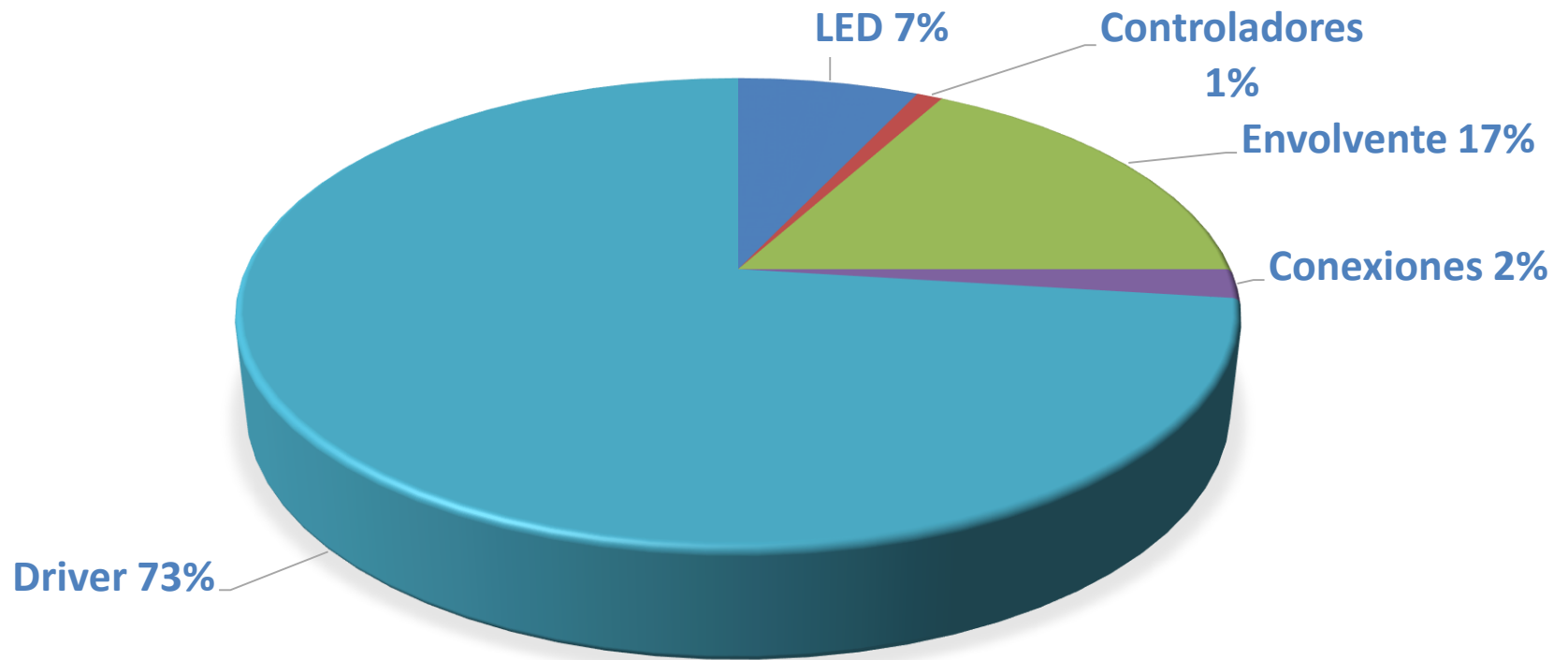

ALERTA PRODUCTO PELIGROSO

Rapid Alert System for dangerous non-food products



Alert number	A12/0625/16
Category	Lighting equipment
Risk level	Serious risk
Product user	Consumer
Product	LED ceiling light
Brand	[REDACTED]
Name	LED Panel Light
Type/number of model	LED power supply:WG-(6W--9W), Light:42862
Batch number/Barcode	8421776085404
OECD Portal Category	78000000 - Electrical Supplies
Description	LED ceiling light supplied with a power supply ("LED Driver"). Sold in a brown cardboard box.
Country of origin	Spain
Notifying country	Finland
Risk type	Electric shock
Risk description	The electrical insulation of the power supply unit is not sufficient. The creepage distance between the primary and secondary circuits is too small. The product does not comply with the requirements of the Low Voltage Directive and the relevant European standards EN 60598 and EN 61347.
Measures adopted by notifying country	Measures ordered by public authorities: Recall of the product from end users, Withdrawal of the product from the market
Products were found and measures were taken also in	Spain
Images	Four images showing the product packaging and components. From left to right: 1. A brown cardboard box with a black label. 2. A close-up of the LED panel light with a label that reads "LED PANEL LIGHT" and "Voltage: 100-240V". 3. A close-up of the LED panel light. 4. A close-up of the LED panel light with a label that reads "LED PANEL LIGHT" and "Voltage: 100-240V".

ALERTA PRODUCTO PELIGROSO

Rapid Alert System for dangerous non-food products



Alert number	A11/0133/10
Category	Lighting equipment
Risk level	Other risk level
Product user	Consumer
Product	LED floodlight
Brand	██████
Name	LED Floodlight
Type / number of model	VT-4810 SKU:5722
Batch number / Barcode	3800157605144
OECD Portal Category	78000000 - Electrical Supplies
Description	LED Floodlight in cardboard box.
Country of origin	China
Alert submitted by	Bulgaria
Risk type	Fire
Risk	The conductors in the cable are too thin and could overheat. The product does not comply with the requirements of the Low Voltage Directive and the relevant European standard EN 60950.
Measures adopted by notifying country	Measures taken by economic operators: Withdrawal of the product from the market (By: Manufacturer)
Products were found and measures were taken also in	Slovenia
Images	 A photograph of the retail packaging for an LED floodlight. The box is primarily blue and white with green accents. Text on the box includes "LED FLOODLIGHT", "SUPER SMD - SMD SERIES", "10W = 50W", "100°", and "10 ROOM". There is also a "PREMIUM SERIES" logo and a small image of the floodlight itself. The top of the box has a barcode area that has been redacted with a black box.

ALERTA PRODUCTO PELIGROSO

Rapid Alert System for dangerous non-food products



Alert number	A12/1071/17
Category	Lighting equipment
Risk level	Serious risk
Product user	Consumer
Product	LED Light
Brand	██████
Name	████ Batten
Type / number of model	Various
Batch number / Barcode	Manufactured between December 2015 and May 2017. Barcode: 5410288451756.
OECD Portal Category	78000000 - Electrical Supplies
Description	Various LED lights
Country of origin	India
Alert submitted by	United Kingdom
Risk type	Electric shock
Risk	The through wiring is too thin. If the lights are connected in a string, the wiring could overheat causing damage to the insulation which could result in exposed conductors. The product does not comply with the requirements of the Low Voltage Directive and the relevant European standard EN 60598.
Measures adopted by notifying country	Measures taken by economic operators: Recall of the product from end users (By: Importer)
Products were found and measures were taken also in	Denmark, Estonia, Poland
	



ALERTA PRODUCTO PELIGROSO



ALERTA PRODUCTO PELIGROSO



ALERTA PRODUCTO PELIGROSO



ALERTA PRODUCTO PELIGROSO



ALERTA PRODUCTO PELIGROSO

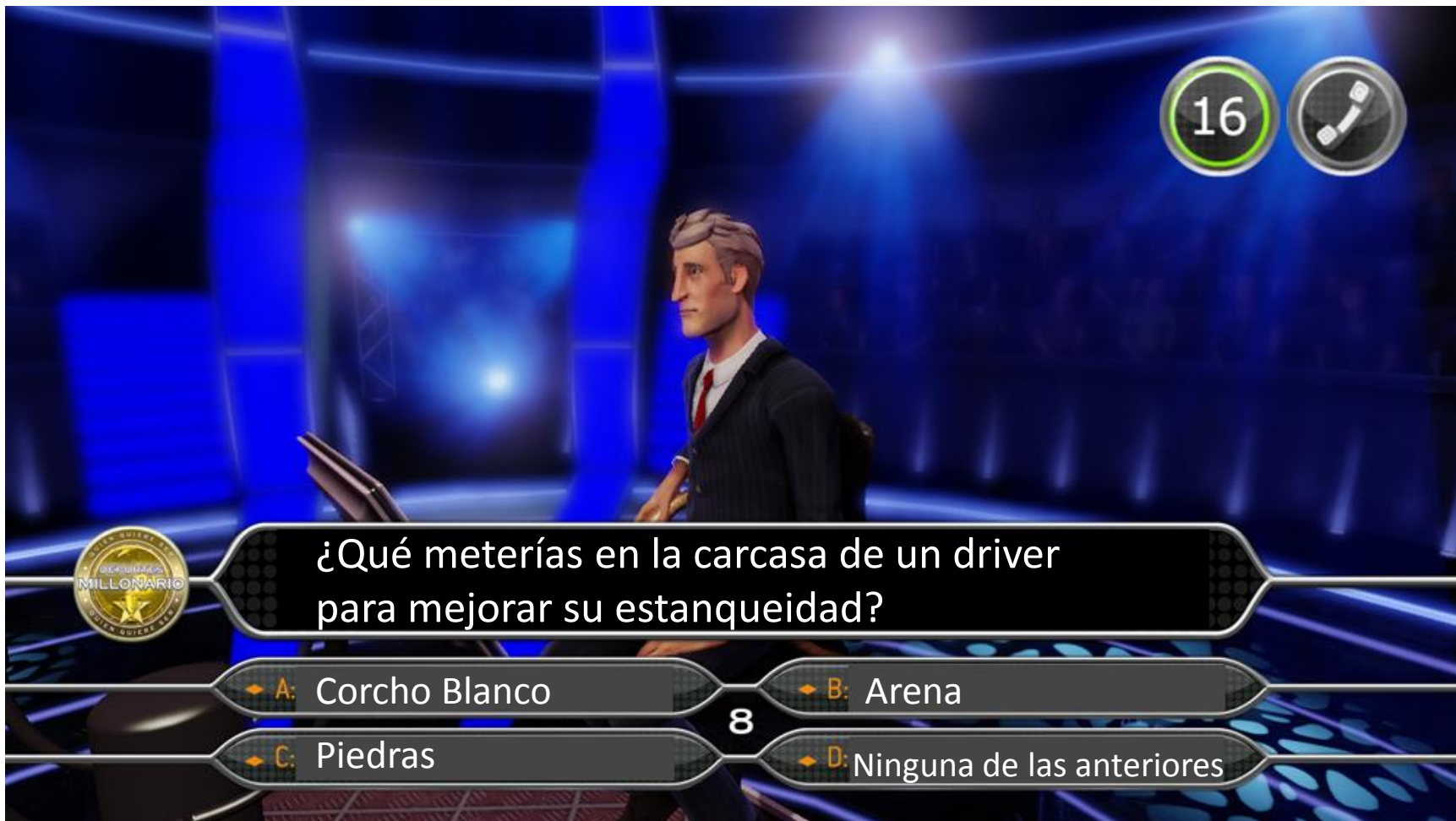

A screenshot from a game titled "Millonario". The background shows a man in a suit standing in a futuristic, blue-lit environment. In the top right corner, there is a circular icon with the number "16" and another icon of a telephone handset. On the left side, there is a gold coin icon with the text "MILLONARIO" and "¿QUIEN QUIERE SER?". The main question is displayed in a white box: "¿Qué meterías en la carcasa de un driver para mejorar su estanqueidad?". Below the question are four answer options: A: Corcho Blanco, B: Arena, C: Piedras, and D: Ninguna de las anteriores. A large number "8" is positioned between the two rows of options.

¿Qué meterías en la carcasa de un driver para mejorar su estanqueidad?

A: Corcho Blanco

B: Arena

C: Piedras

D: Ninguna de las anteriores

8

ALERTA PRODUCTO PELIGROSO



Piedras



- ¿Flujo lumínico Real?
- ¿Eficiencia lumínica Real?
- ¿Potencia consumida Real?
- ¿Se cuentan las pérdidas?
- Gestión Térmica: Disipador
- Driver: PF, THD, Flicker...

VERIFICACIÓN PRODUCTO

Flujo
Lumínico

Eficiencia
Lumínica

Potencia
consumida

LED

SISTEMA

VERIFICACIÓN PRODUCTO

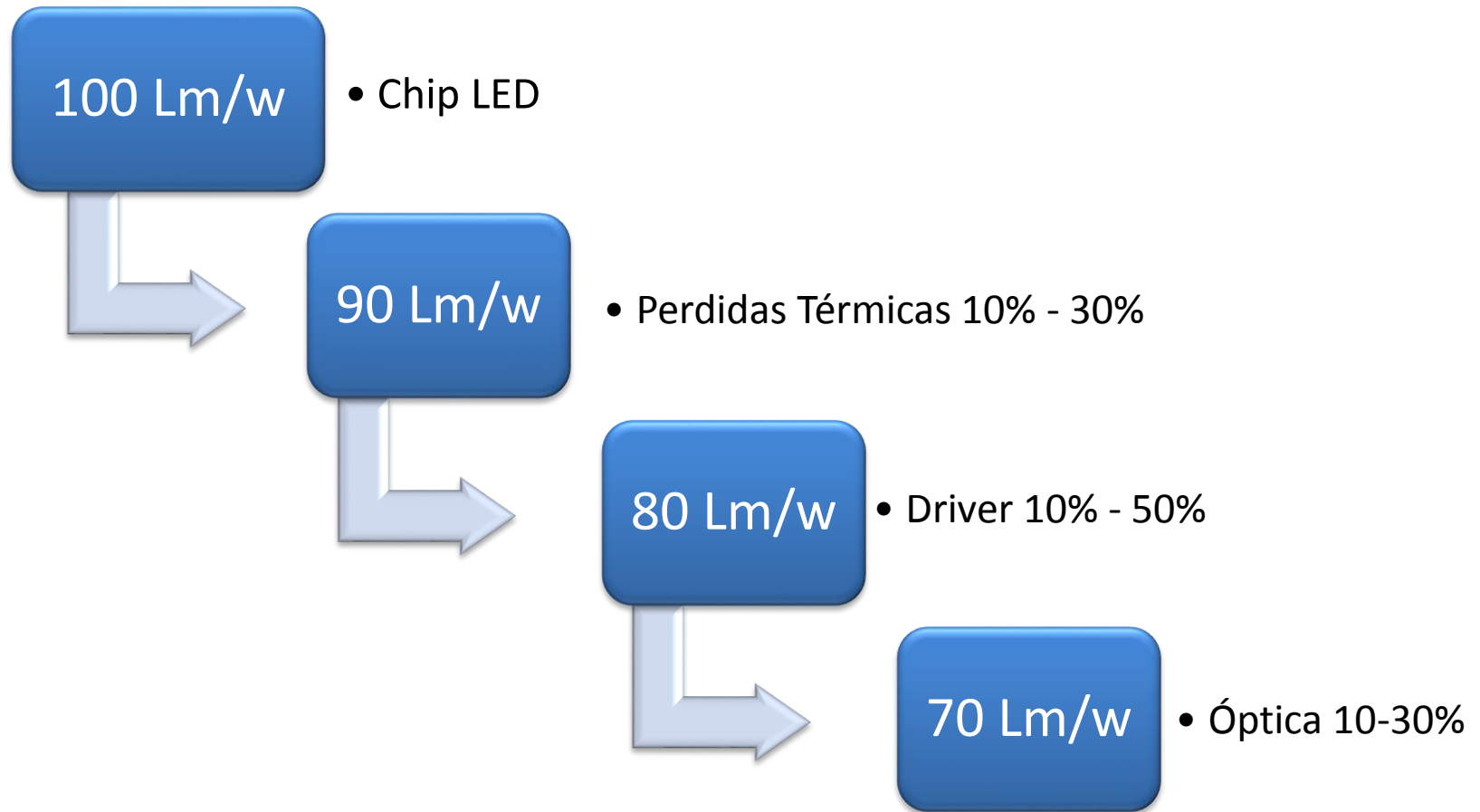

VERIFICACIÓN PRODUCTO



VERIFICACIÓN PRODUCTO



DL PLANO 18W 1800LM	DL 20W 2400LM
P=18,77W	P=19,27W
0,66	0,97
1.200 LM	2.400 Lm
3300 Lux	6700 Lux
70 Lm/w	120 Lm/w
L70 B30 15.000H	L70 B30 60.000H
UGR>25	UGR>22

VERIFICACIÓN PRODUCTO

DISIPACIÓN DE CALOR LATERAL

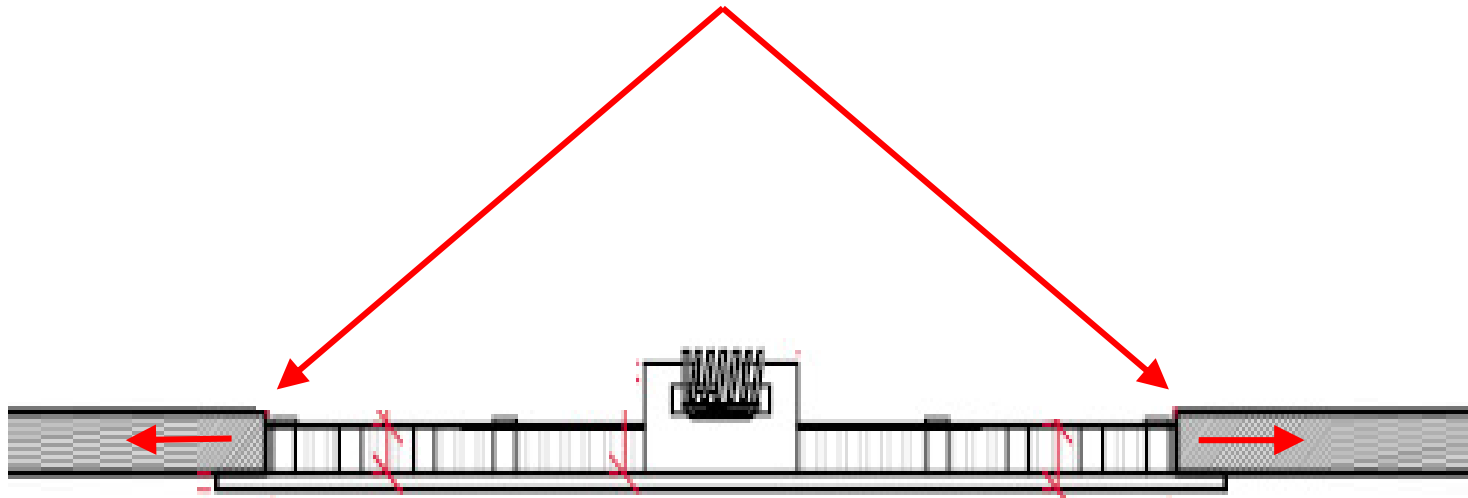

VERIFICACIÓN PRODUCTO

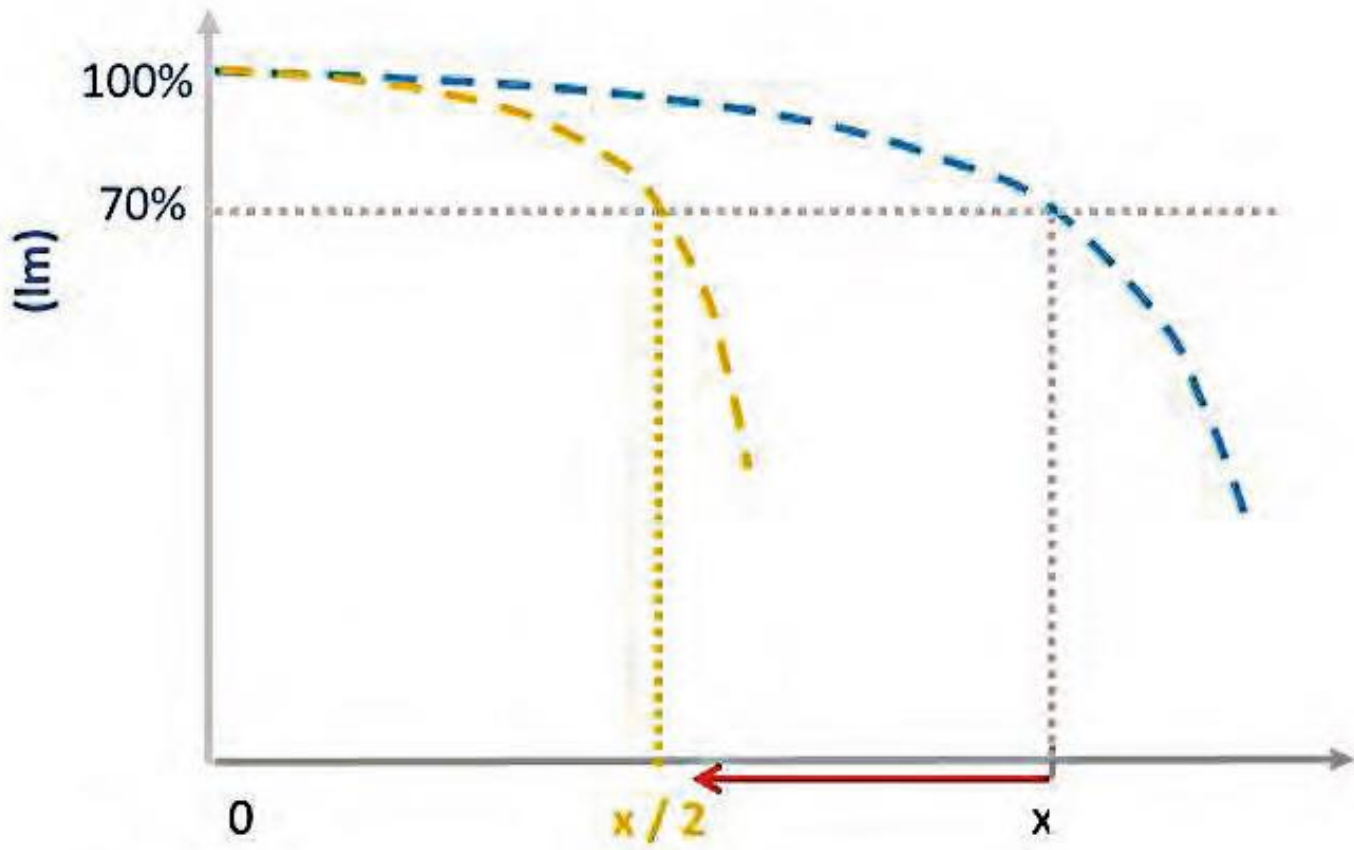

OLED



OLED



OLED



- Luz Natural, uniforme y comfortable
- No Deslumbra, No caliente, No emite UV
- Mas delgado y flexible.

OLED

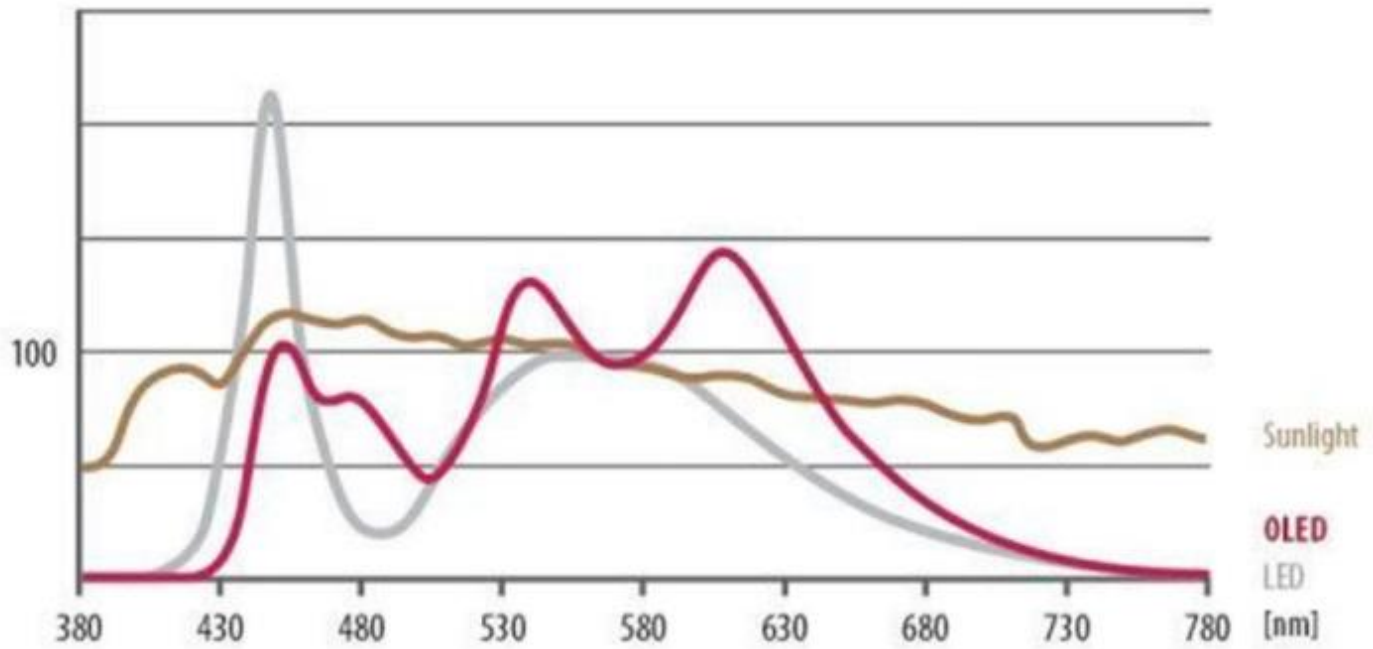

* Normalization (Relative Distribution) based on the value (100) of 560nm

OLED

LED Only

LED + OLED

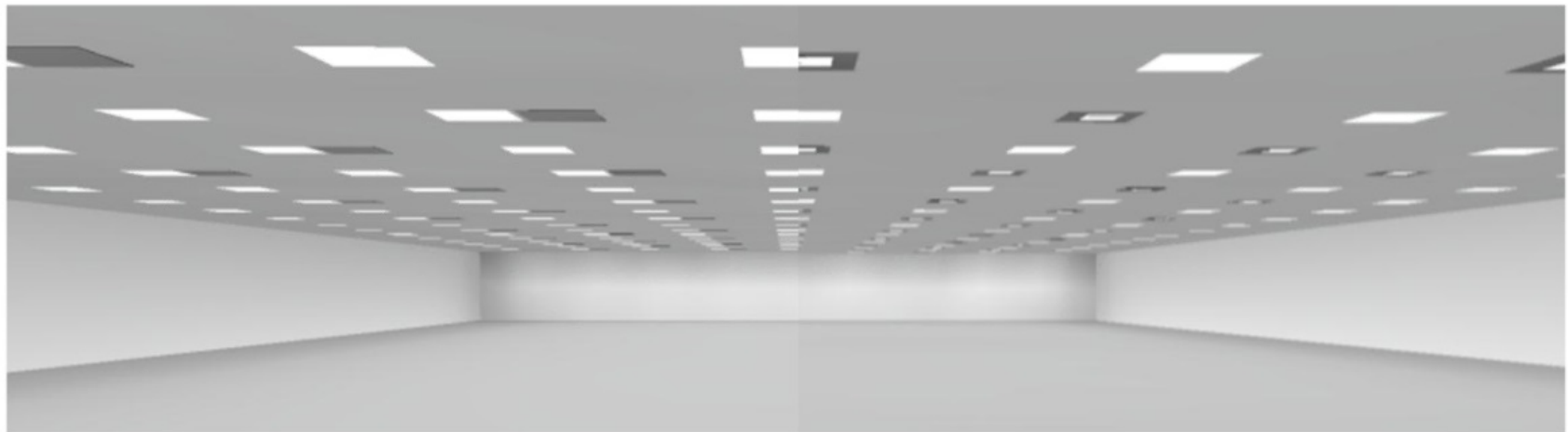

Category		LED	LED+OLED
Light Performance	Illuminance (Lux)	603.5	602.5
	Max (Lux)	694	694
	Min (Lux)	240	281
Uniformity (Uo) Min/Avg		0.397	0.467

*Higher uniformity reduces iris movement, reducing eye fatigue

OLED

LED

OLED

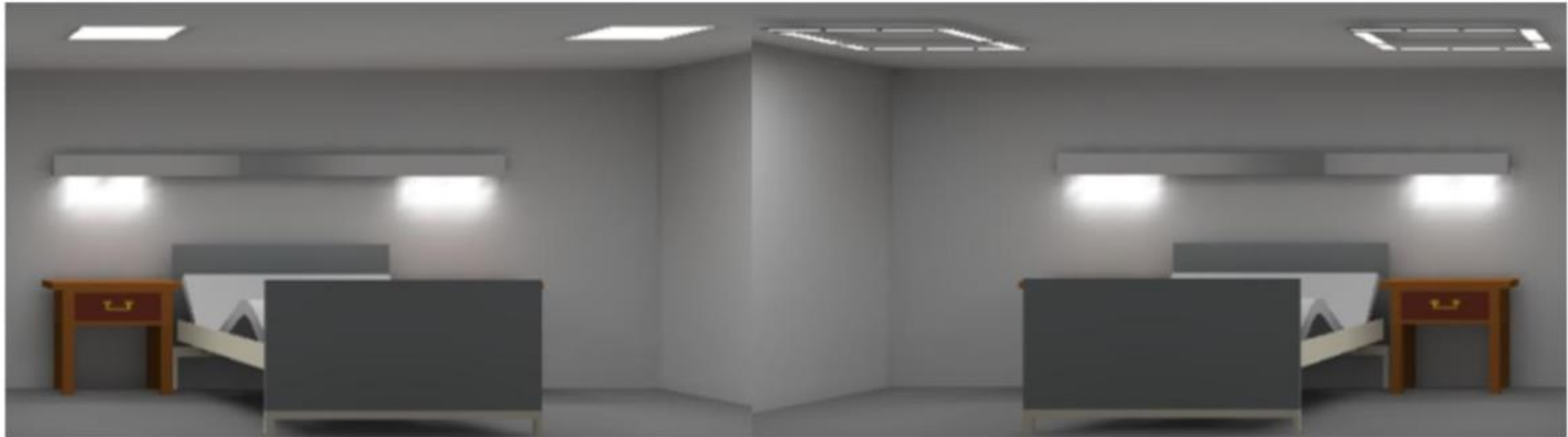

Category		LED	OLED
Light Performance	Illuminance (Lux)	320.9	316.2
	Max (Lux)	498	457
	Min (Lux)	148	162
UGR* (Unified Glare Ratings)		@ 0 Deg: Avg = 14.92 (max = 36, min = 10) @ 90 Deg: Avg = 12.82 (max = 36, min = 10) @ 180 Deg: Avg = 15.10 (max = 36, min = 10) @ 270 Deg: Avg = 12.73 (max = 21, min = 10)	@ 0 Deg: Avg = 10 (max = 10, min = 10) @ 90 Deg: Avg = 10 (max = 10, min = 10) @ 180 Deg: Avg = 10 (max = 10, min = 10) @ 270 Deg: Avg = 10 (max = 10, min = 10)

*Criterion: 10 (Imperceptible) 13 (Just perceptible) 16 (Perceptible) 19 (Just acceptable) 22 (Unacceptable) 25 (Just uncomfortable) 28 (Uncomfortable!)

OLED

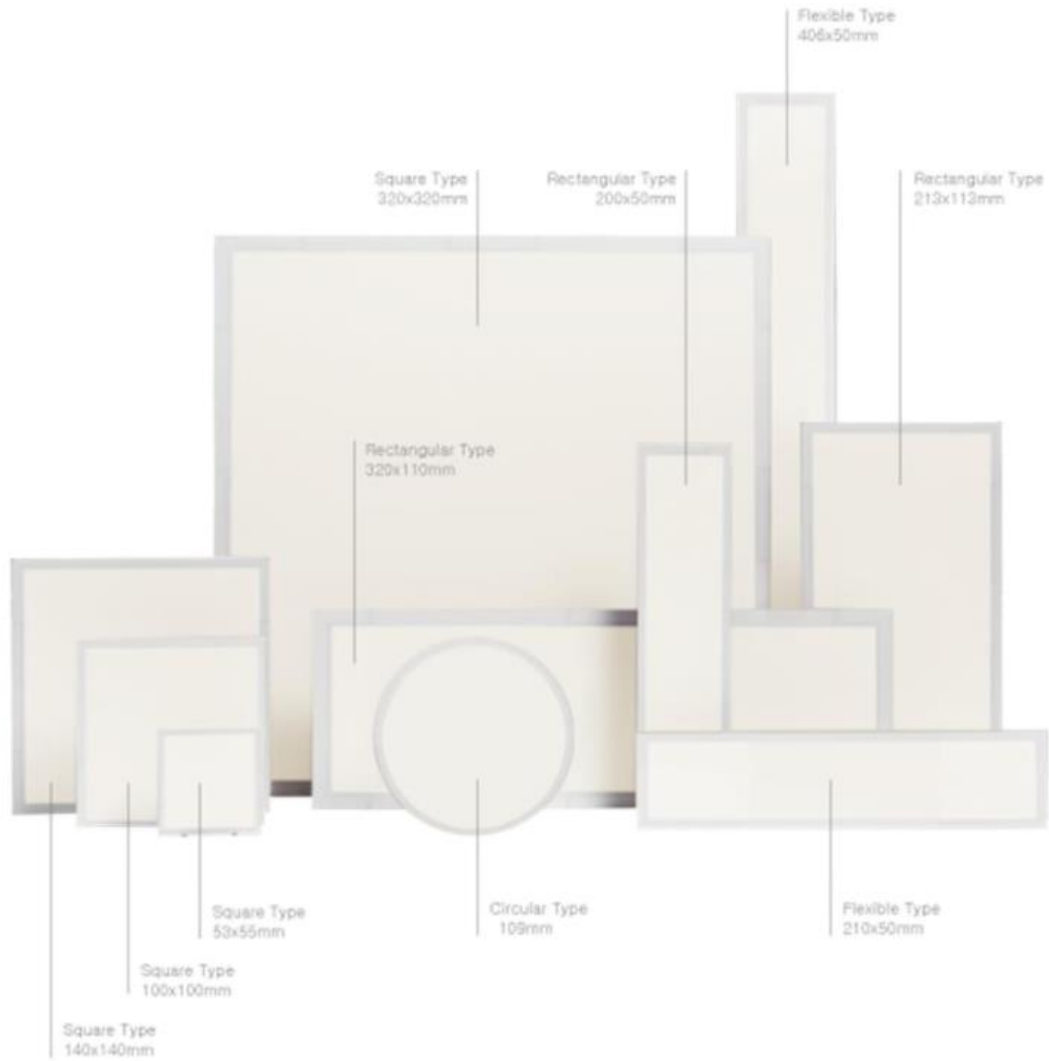

OLED

Design combined with Comfort

: Providing the visitors with the pleasantness of OLED Light formed into unique and flexible curves



Unique
Flexible
Curve

Classic
Emphasis

OLED for Hotel Lighting

LOBBY APPLICATION

Light + Building 2014



OLED

OLED panels: rigid (200x50mm)
Material: aluminum, wood



OLED



OLED



OLED & UNIVERSIDAD SEÚL



GESTIÓN DE LA ILUMINACIÓN Y SMART LIGHTING

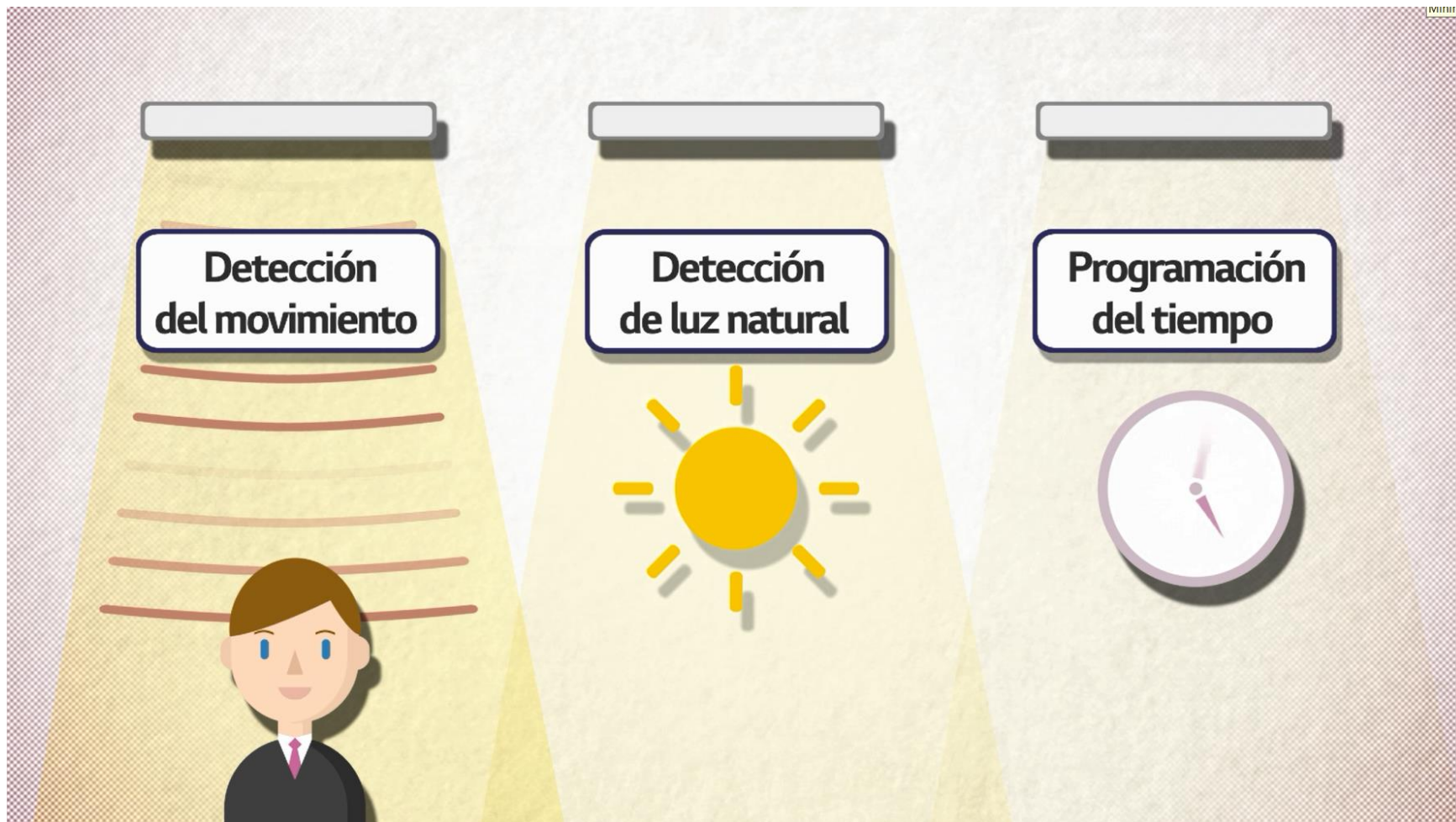

GESTIÓN DE LA ILUMINACIÓN Y SMART LIGHTING



HUMAN CENTRIC LIGHTING

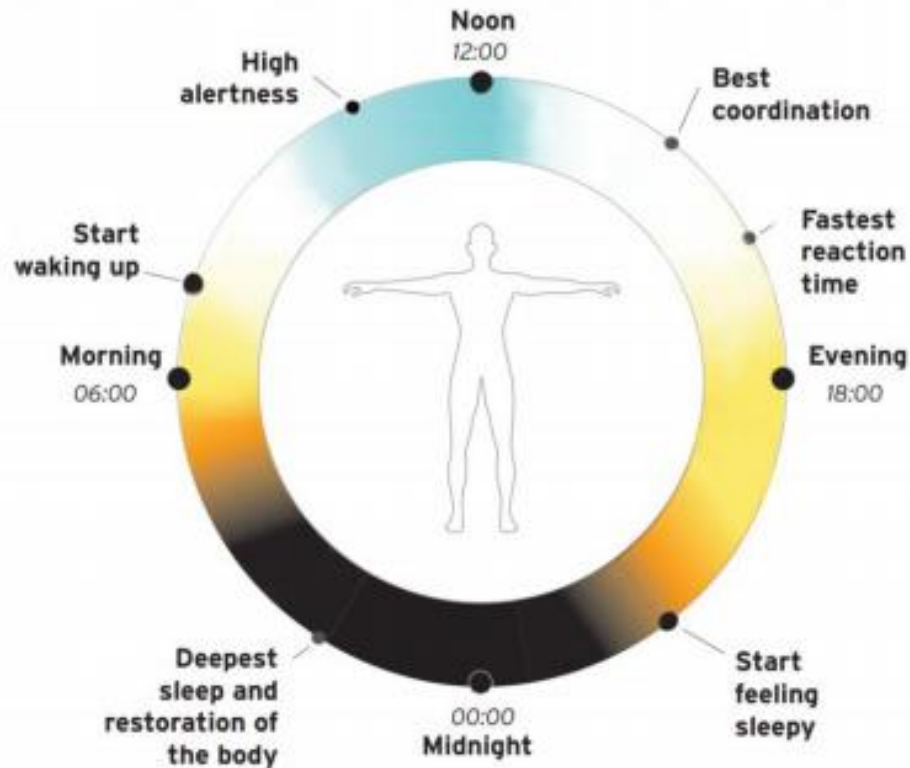

Morning

*Cool light,
High intensity*



Afternoon

*White light,
High intensity*



Evening

*Warm light,
Low intensity*



Night

No light

HUMAN CENTRIC LIGHTING

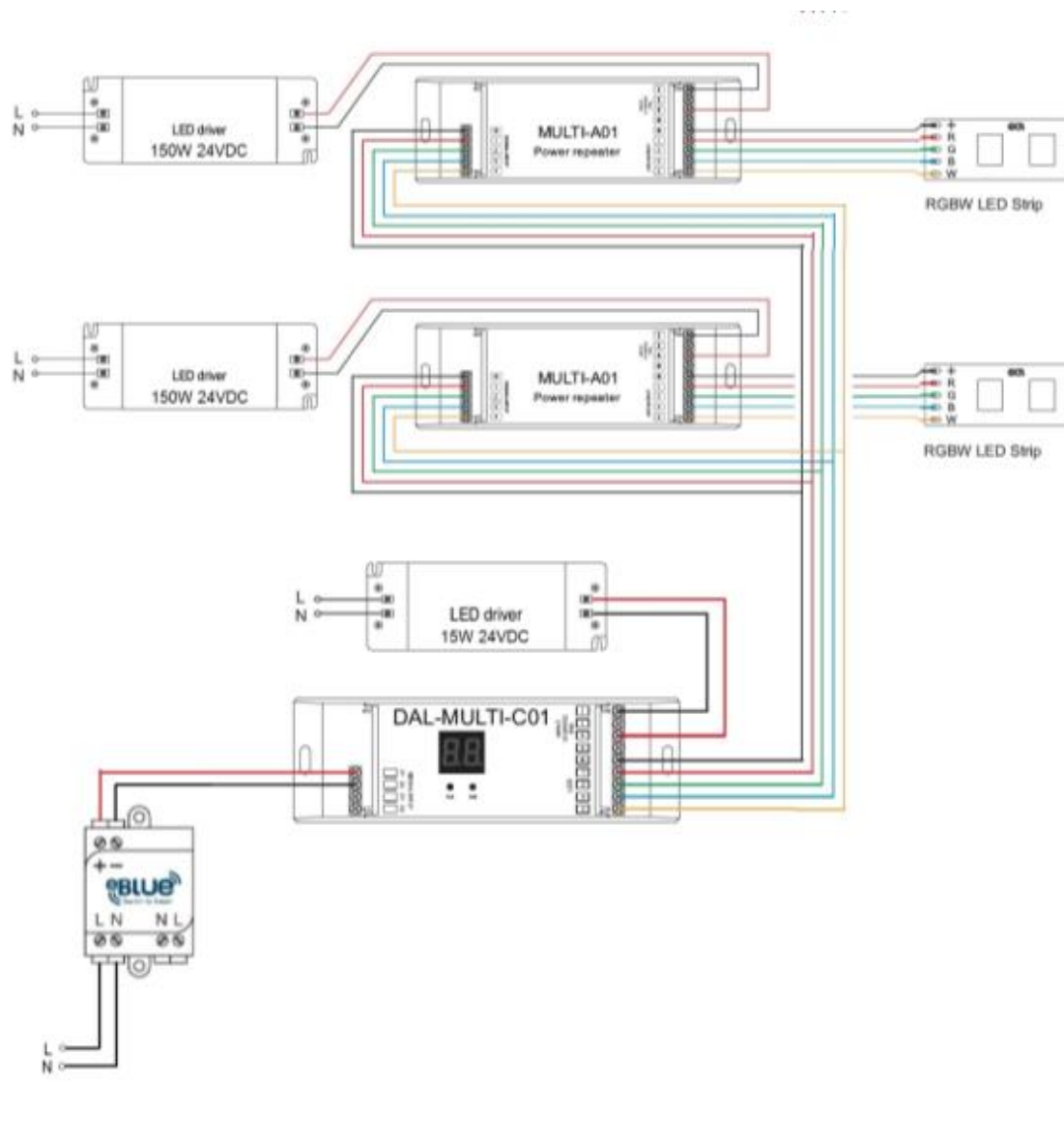

LA ILUMINACIÓN LED TIENE MÚLTIPLES VENTAJAS

LA ILUMINACIÓN LED TIENE MÚLTIPLES VENTAJAS



CALIDAD DE LUZ

CALIDAD DE LUZ



CALIDAD DE LUZ



$(IRC + CCT) * \text{FOTOMETRÍA}$

CALIDAD DE LUZ

IRC ALTO (80-100)



Temperatura de Color Adecuada



Óptica de Calidad



(IRC + CCT) * FOTOMETRÍA

ÓPTICAS Y REFLECTORES

LENTE



REFLECTOR



ÓPTICAS Y REFLECTORES

LENTE

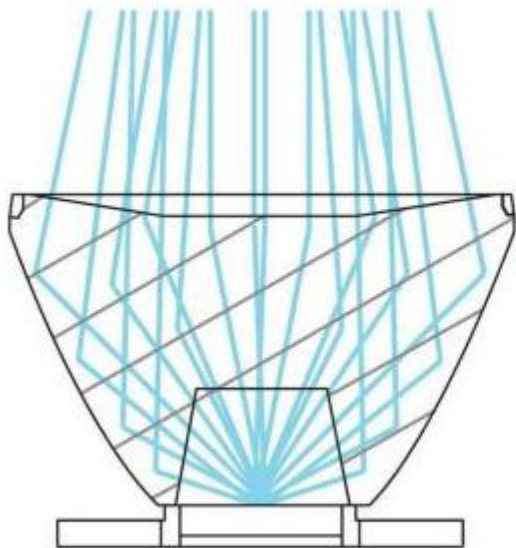

REFLECTOR

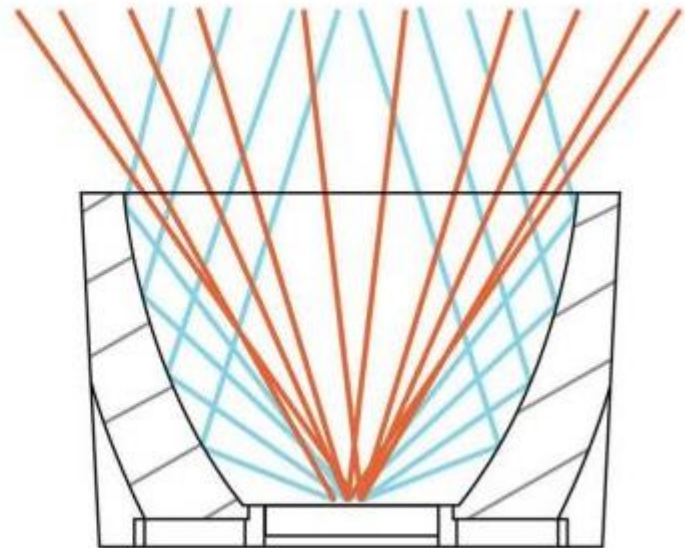

ÓPTICAS Y REFLECTORES

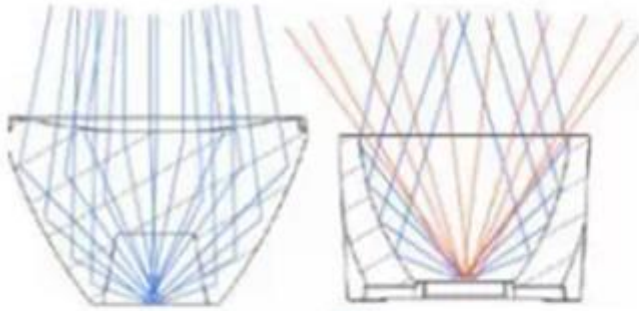

TIR lens' typical light distribution has a sharp cut-off.

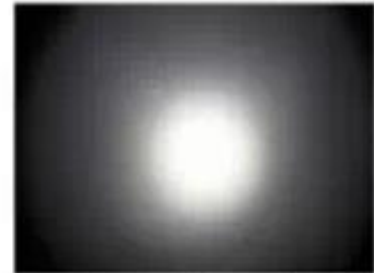

Reflectors produce much softer cutoff even if the viewing angle is same.

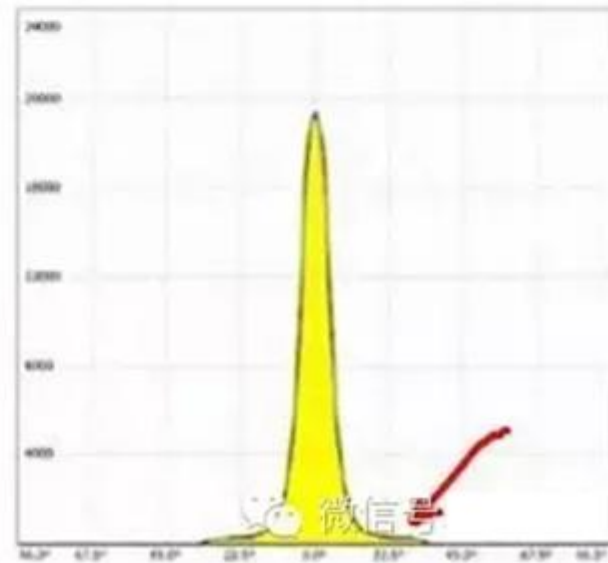
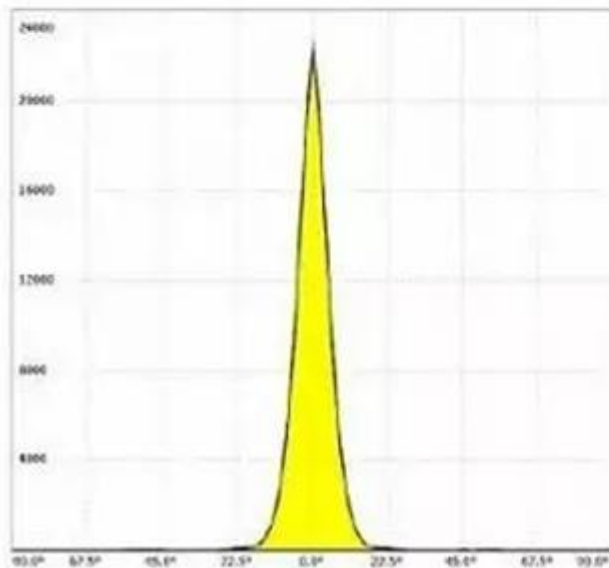

- LENTE TIR

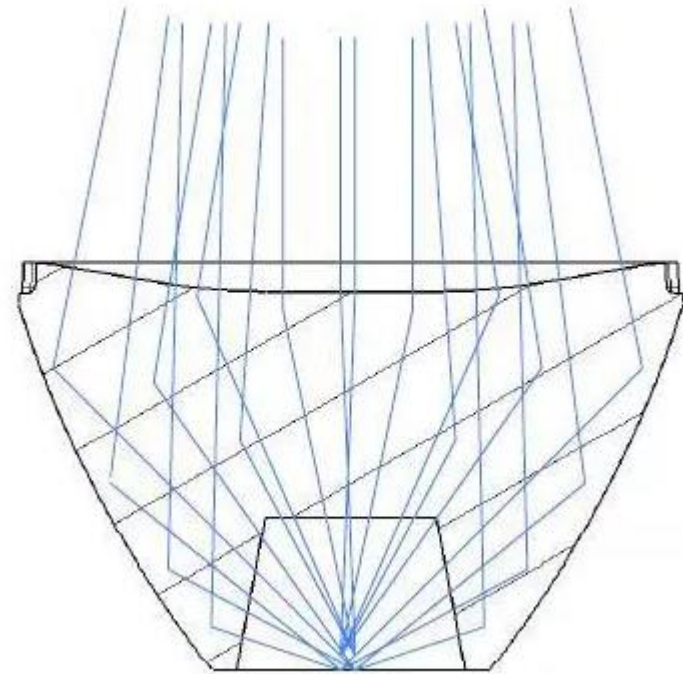

TIR = Total Internal Reflection

ÓPTICAS Y REFLECTORES



Good quality COB



Color distortion



ÓPTICAS Y REFLECTORES

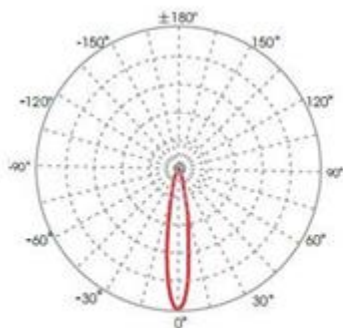

24°

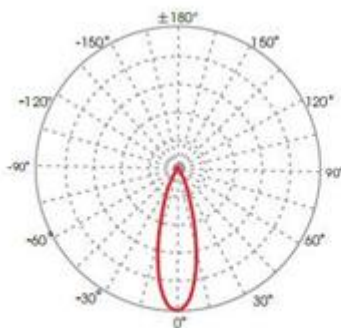

38°

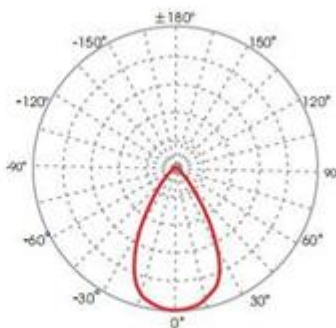

60°

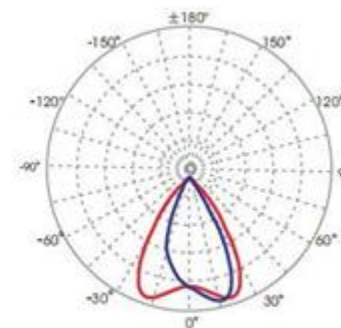

80°x45°



- Elegir bien la Temperatura de Color CCT
- Alto IRC > 90
- Utilizar luminarias con una buena óptica
- **Crear claros y oscuros, NO uniformidad**
- Focalizar el producto

JUGUETERÍA

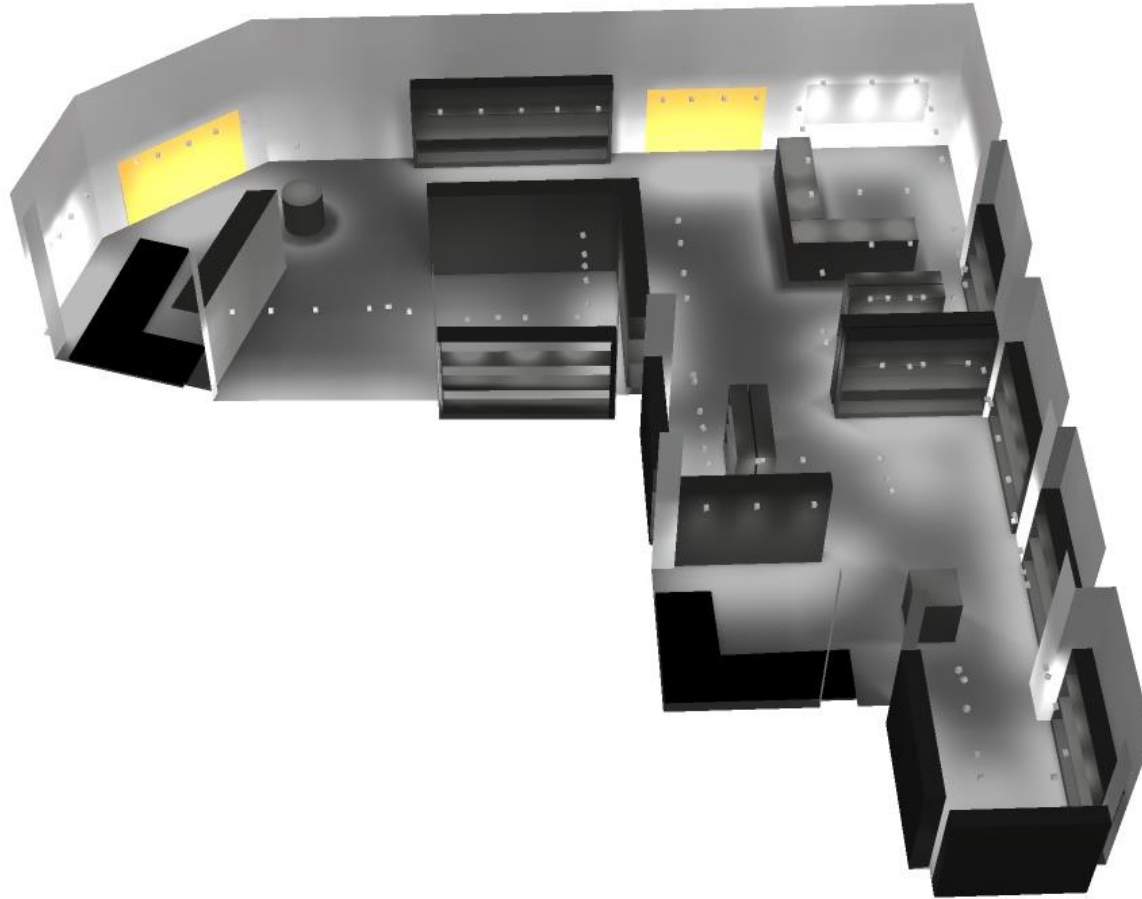

JUGUETERÍA



VOLVO

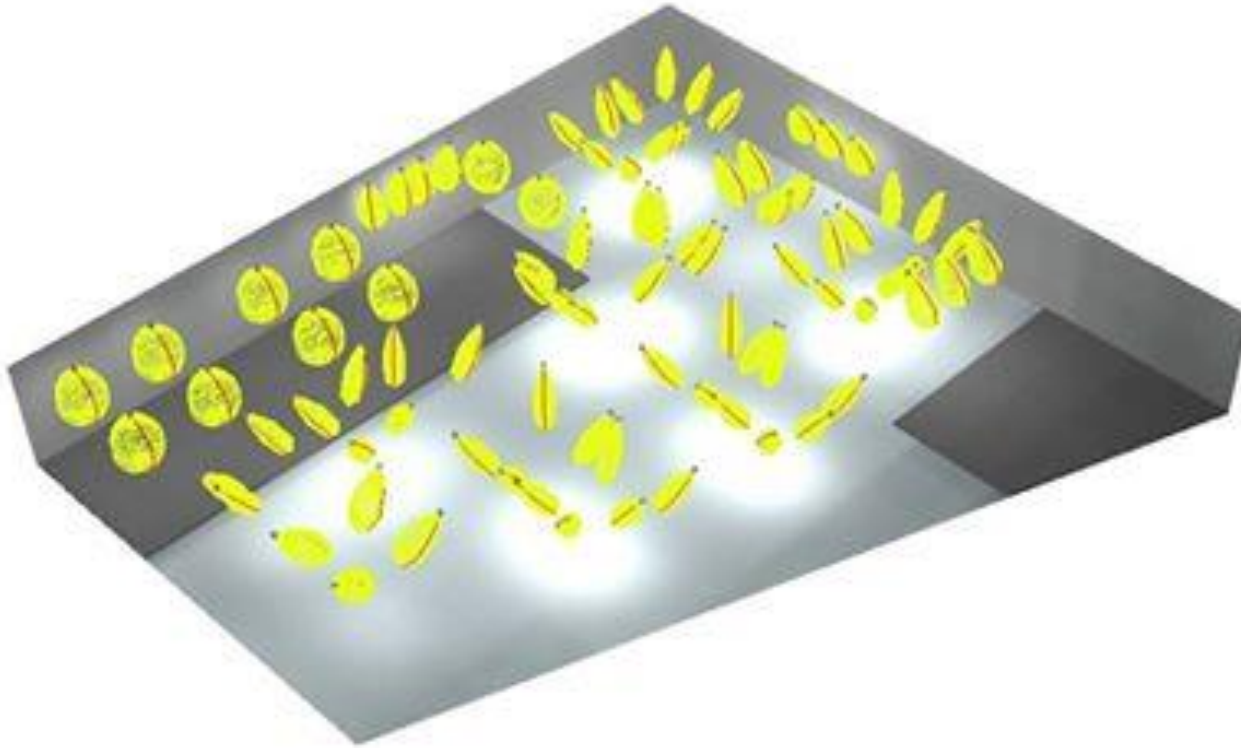

VOLVO



ILUMINACIÓN EN OFICINAS Y ESPACIOS DE TRABAJO

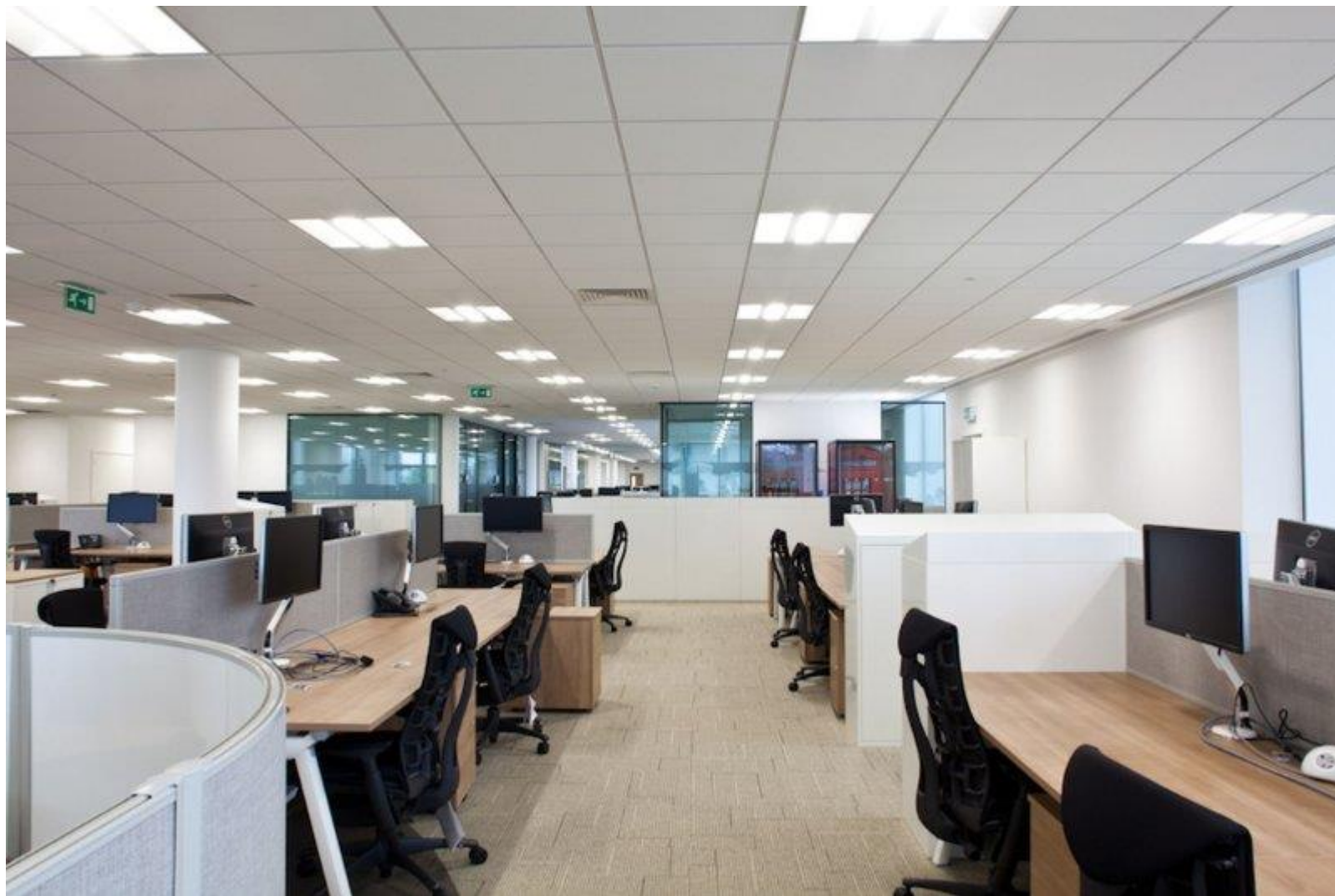

ILUMINACIÓN EN OFICINAS Y ESPACIOS DE TRABAJO



- Luminaria: Eficiencia, Diseño, **UGR**, Distribución...
- Multisensor: Movimiento, lumínico y temporal.
- Inteligencia: programamos parámetros (Evitar Fallo Humano)
- Comunicación inalámbrica (Ahorro en instalación)
- UNE 12464.1: Norma Europea sobre la iluminación para interiores.

ILUMINACIÓN EN OFICINAS Y ESPACIOS DE TRABAJO



*La detección de la luz natural ocurre automáticamente.

Cada vez que llega un ocupante a su espacio del escritorio, las iluminaciones en el área inmediata se enciende hasta el nivel máximo. Mientras tanto, las demás iluminaciones permanecen en el nivel medio.

INDUSTRIAL



- Luminaria: Eficiencia, Diseño, **Disipación...**
- Multisensor: Movimiento, lumínico y temporal.
- Inteligencia: programamos parámetros (Evitar Fallo Humano)
- Comunicación inalámbrica (Ahorro en instalación)
- UNE 12464.1: Norma Europea sobre la iluminación para interiores

INDUSTRIAL

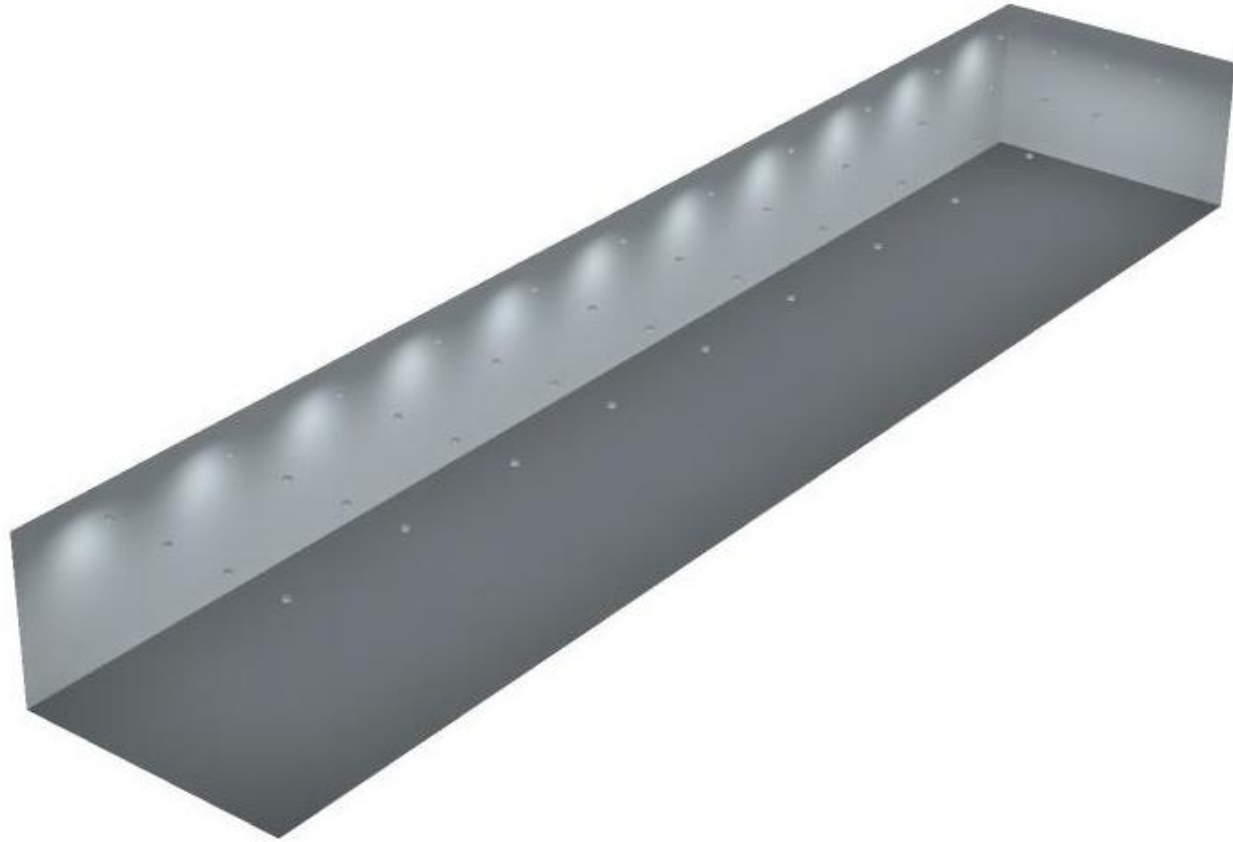

INDUSTRIAL

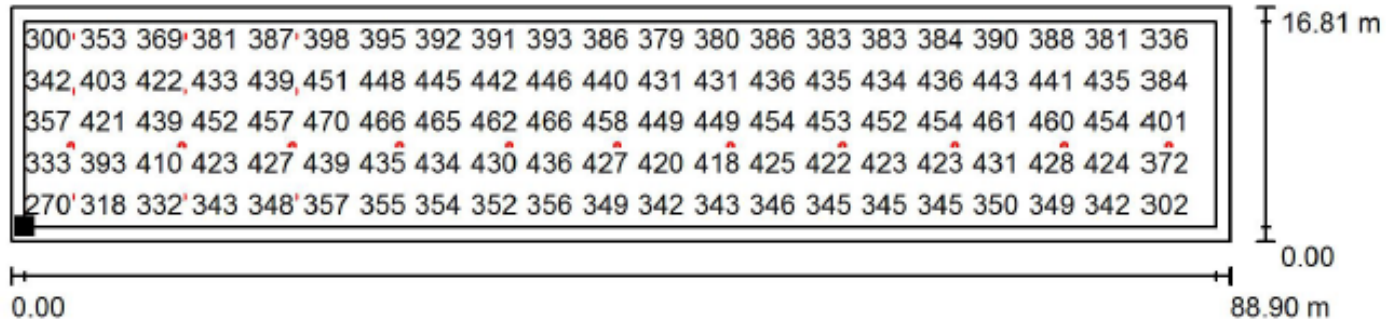

Valores en Lux, Escala 1 : 636

No pudieron representarse todos los valores calculados.

Situación de la superficie en el local:

Plano útil con 1.000 m Zona marginal

Punto marcado:

(131.200 m, 163.588 m, 1.000 m)

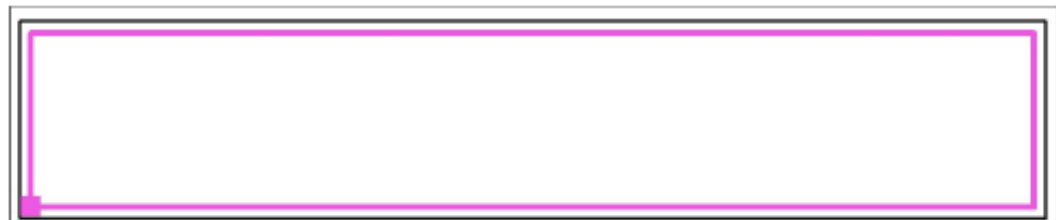

Trama: 128 x 64 Puntos

E_m [lx]
400

E_{min} [lx]
222

E_{max} [lx]
475

E_{min} / E_m
0.554

E_{min} / E_{max}
0.467

INDUSTRIAL

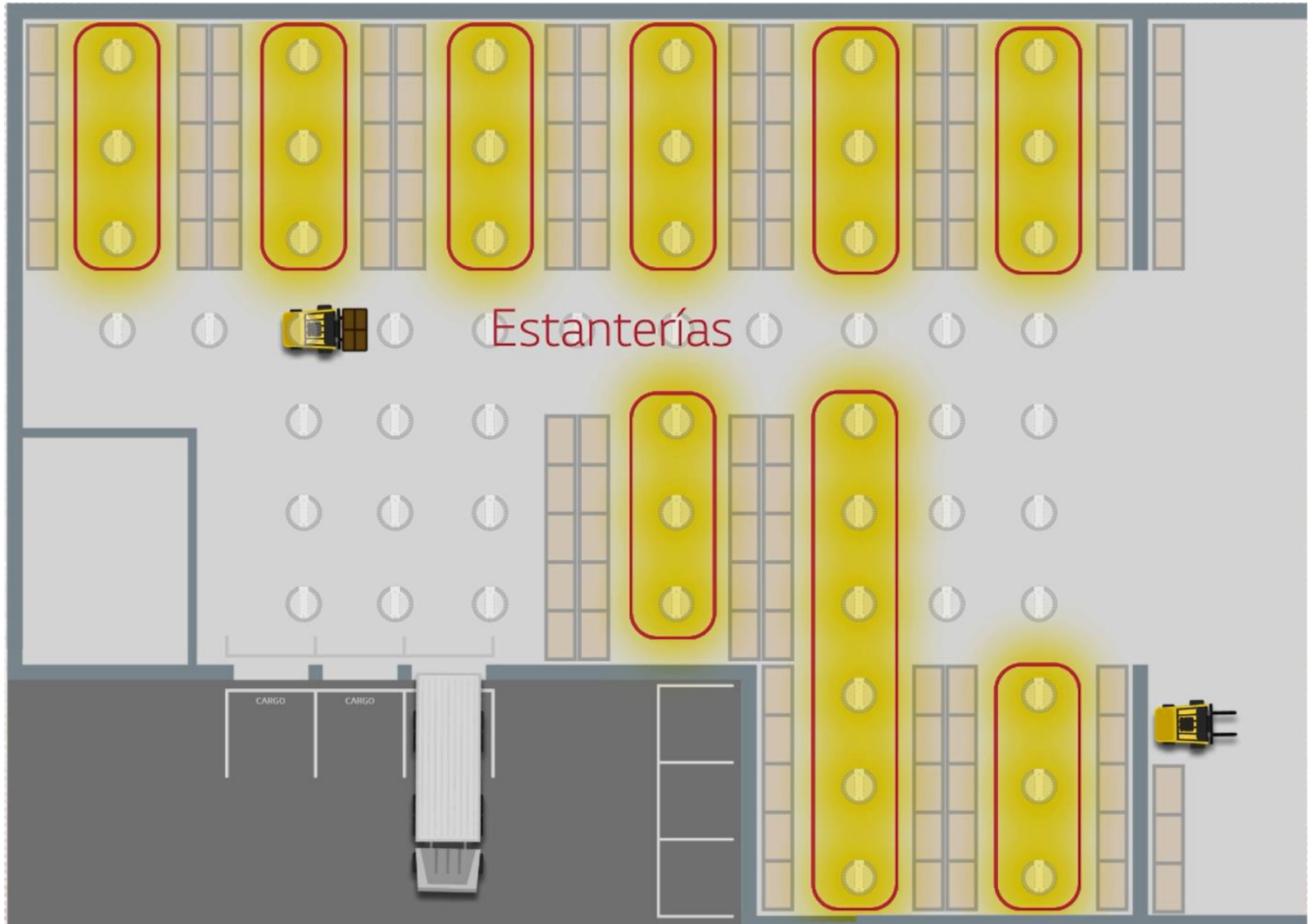

PISTA DE PÁDEL



PISTA DE PADEL

Potencia nominal
160 W

Factor de potencia
0,97

Fuente de luz
Nichia SMD

Flujo luminoso inicial
21000 lm

Eficiencia luminosa
130 Lm/W

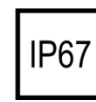
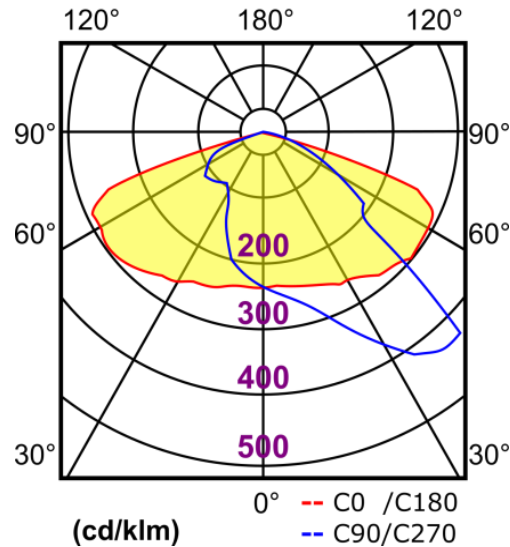

PISTA DE PADEL



PISTA DE PADEL

PADEL 3 - 500lux Emed / Pádel 1 trama de cálculo (PA) / Gráfico de valores (E, perpendicular)

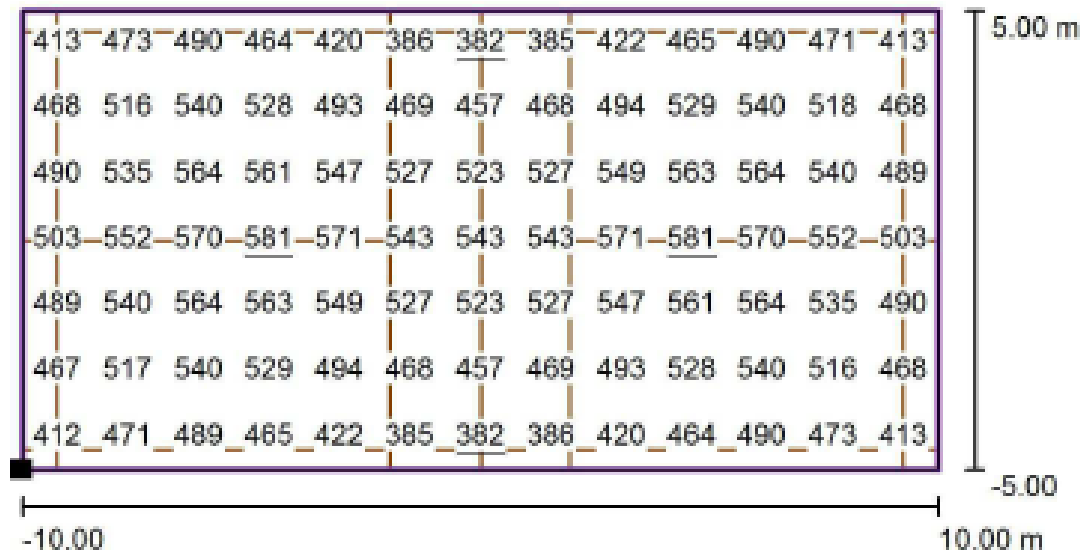

Trama: 13 x 7 Puntos

E_m [lx]
500

E_{min} [lx]
382

E_{max} [lx]
581

E_{min} / E_m
0.77

E_{min} / E_{max}
0.66

PISTA DE PADEL

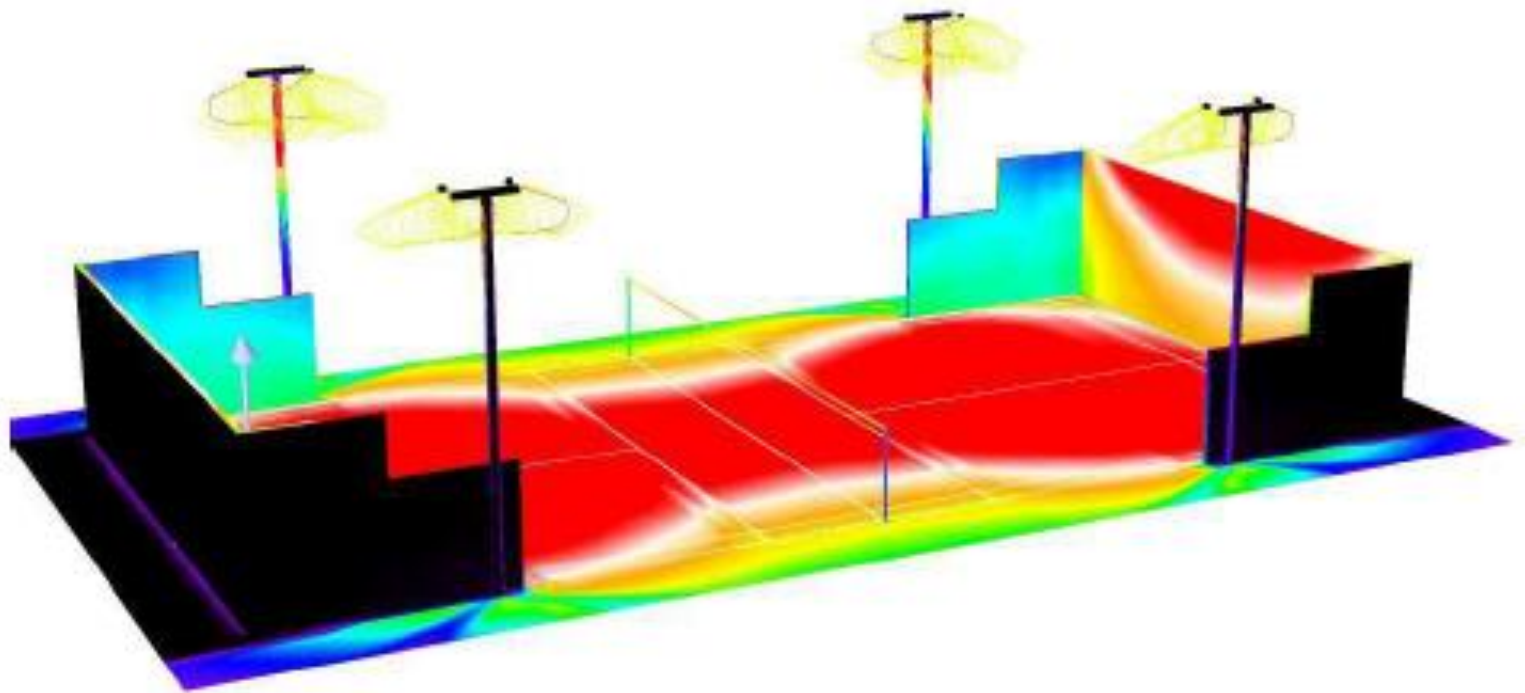

10

71.25

132.50

193.75

255

316.25

377.50

438.75

500

lx

PISTA DE PADEL

Medición real

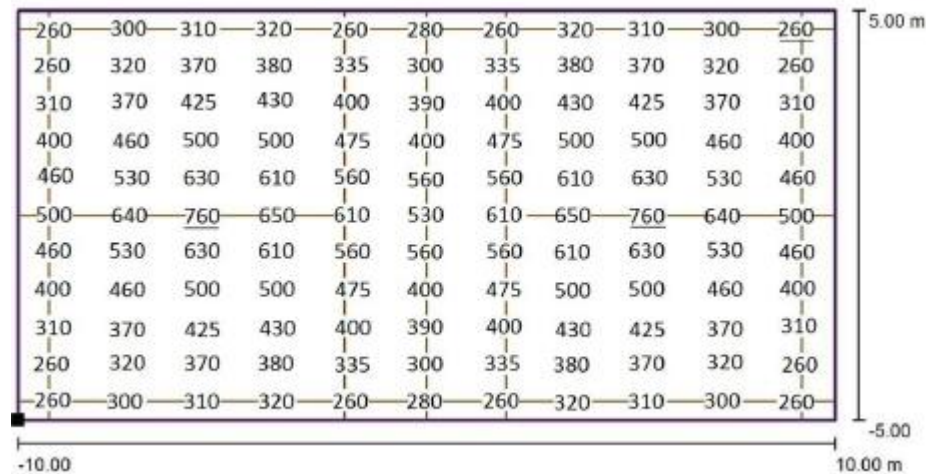

PISTA DE PADEL

Comparación



Tabla de resultados

	LX MEDIA	LX MIN	LX MAX	UNIFO	AHORRO
Luminaria Modular LED 160W	425	260	760	0,61	
HM "NUEVO" 470W	403	234	585	0,58	67%
HM BLANCO FRIO 470W	257	120	337	0,47	67%
LED 4000K 200W	230	80	327	0,38	15%
LED 6000K 200W	335	175	440	0,52	15%

VIAL



Modularidad

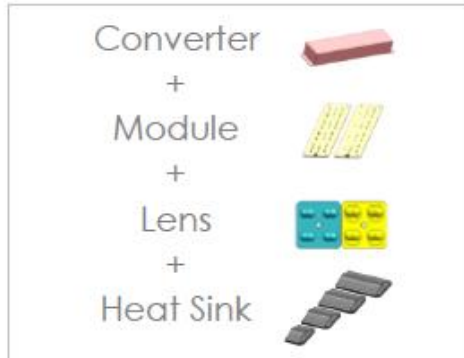

Fácil Mantenimiento



Disipador

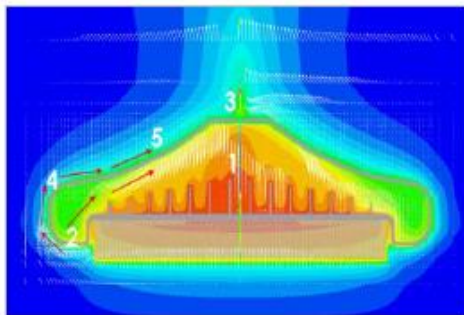

Smart City

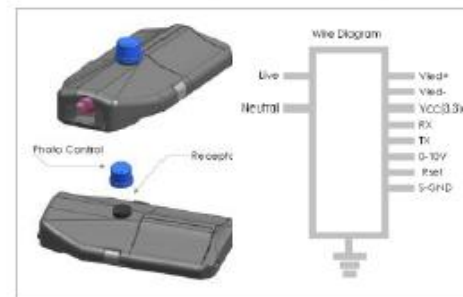

VIAL



VIAL

Efficiently Deliver Light Where You Need It

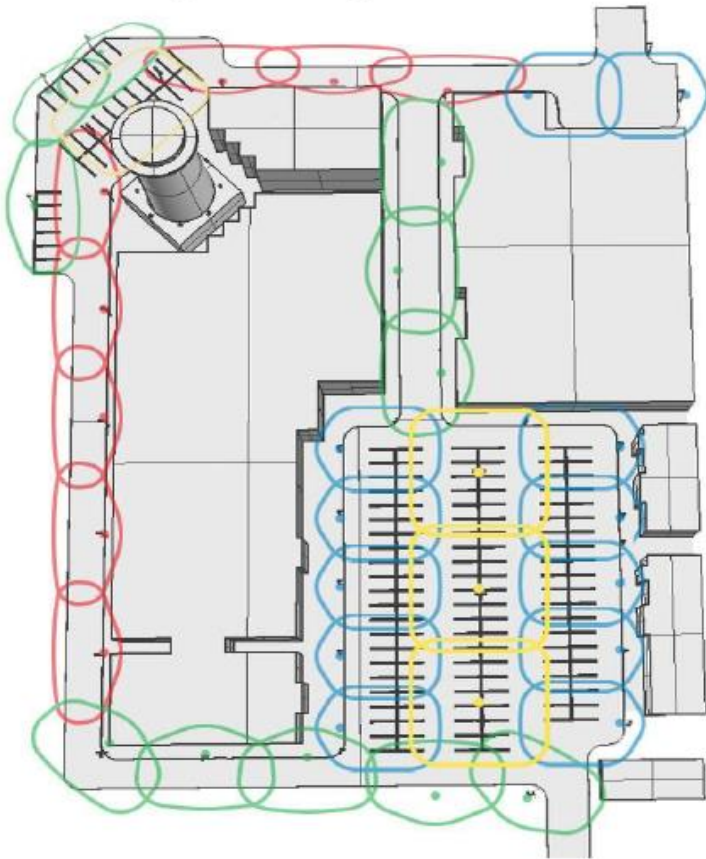

•Optical Distribution



Type II



Type III



Type IV



Type V

*IESNA Type I-V Available, Type IV will be available

•Advanced Optic Design

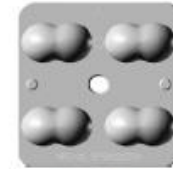

Lens A



Lens B

•An Example of Various Light Distribution of Type I

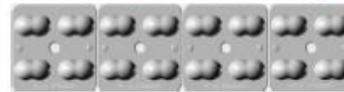

VIAL



Contaminación Lumínica

- Tendencia utilizar temperaturas mas cálidas.
- 1700K – 3000K



VIAL

Software de monitorización y gestión

- Configuración, control y mantenimiento preventivo de luminarias punto a punto.
- Aplicación intuitiva y de fácil instalación y manejo.
- Multidispositivo y multiusuario.
- Generación de informes

Base de datos centralizada

- Instalación local o en la nube.
- Sistema seguro y protegido.
- Interoperable con cualquier plataforma de gestión de ciudad.
- Inteligencia de negocio y tratamiento de datos.

Driver LED

- Funcionalidad totalmente programable.
- Alta eficiencia.
- Notificación de alarmas.
- Alta protección ante sobretensiones (10KV).

Red de luminarias

- Identificación única de luminaria basada en direccionamiento IP.
- Compatible con entornos IoT.
- Preparado para sensorización adicional e intercambio de datos con sistemas externos
- Red mesh multisalto.

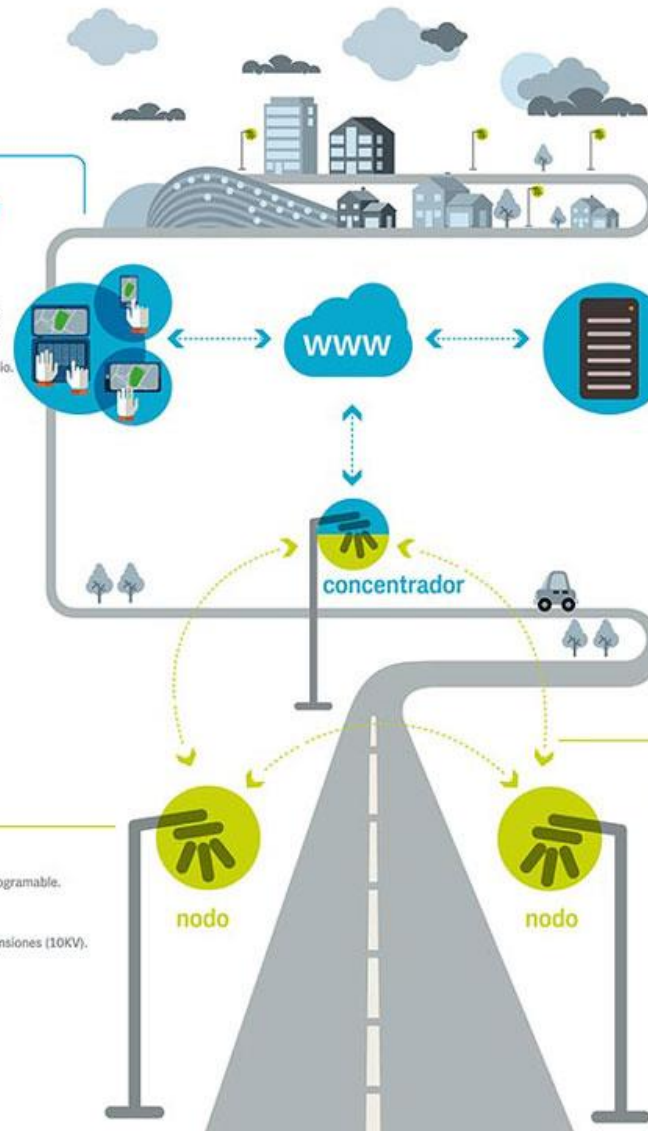

FUTURO DE LA TECNOLOGÍA LED

- Led smd mas pequeños
- Más eficientes (<683 lm/w)
- Calidad de la luz
- Nuevos materiales
- Diseño de luminarias led
- Luminarias de gran potencia.

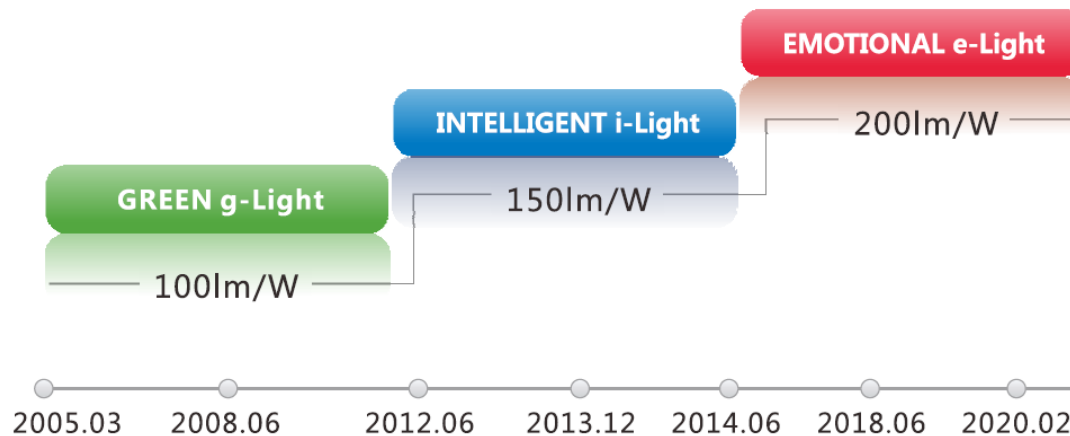



¡Gracias por vuestra atención!

Alejandro Baselga

abaselga@elt.es

www.elt.es