

eConcept

T É C N I C O

essential

prilux 

eConcept

T É C N I C O



Flexilight

Flexilight LED	10
Flexilight LED Flashing	11
Flexilight RGB	12
Flexilight CW/WW	13
Flexilight LED Mini Neon	14
Flexilight LED Double Neon	15
Flexilight LED Brite	16
Flexilight Instant	19



Led Exterior

Outdoors Led
Led à l'extérieur
Led ao ar livre

String plus 180	20
String plus 180 Flashing	21
String Plus 100 Minimalist	22
String Plus 100 Flashing Minimalist	22
String Plus RGB	23
String Plus CW/WW	24
Techo de Luz	25
Screenlight	26
Screenlight Flashing	27
Screenlight Minimalist	28
Screenlight Flashing Minimalist	29
Screenlight RGB	30
Icicle	31
Icicle Flashing	32
Icicle Minimalist	33
Icicle Flashing Minimalist	33
Icicle RGB	34
Red	35



deco

LED Fireworks	36
Branch LED	37

Fall Lite LED SMART	38
Fall Lite LED	38
esSense Ball LED basic	39
esSense Ball LED	39
Pebetero LED	40
Guirnalda E14/E27	40



motivos
motif
motifs
motives

Letreros Corporeos	42
Letreros	43
Motivos farola, calle y fachada	48
Motivos mini	56
Motivos 3D	61



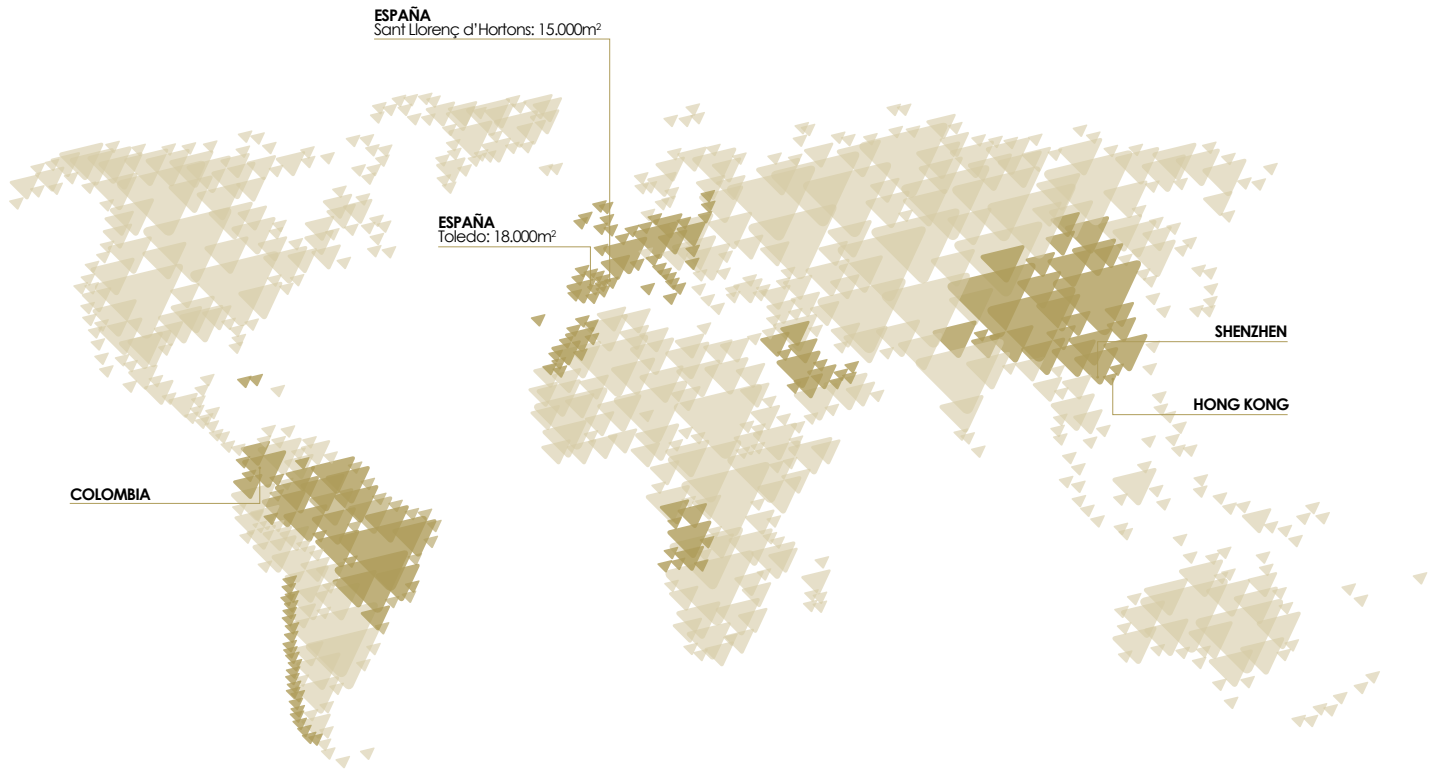

Prilux es una empresa española con más de 35 años de experiencia en el sector de la iluminación.

En Prilux nos esforzamos día tras día por ser una de las empresas de iluminación de referencia a nivel mundial al ofrecer al mercado, alta tecnología en iluminación con una relación calidad/precio insuperable y un asesoramiento personalizado a nuestros clientes en sus proyectos ofreciendo un servicio más eficaz.

Somos un equipo joven, dinámico y multidisciplinar compuesto por más de 200 profesionales entre los cuales más de 20 ingenieros forman parte del departamento de I+D, proyectos y de nuestro laboratorio propio.

Prilux is a Spanish company with more than 35 years of experience in the lighting sector.

At Prilux we strive day after day to be one of the world's leading lighting companies by offering the market high technology in lighting with an unbeatable quality / price ratio and personalized advice to our clients on their projects by offering a more service, effective.

We are a young, dynamic and multidisciplinary team made up of more than 200 professionals, among which more than 20 engineers are part of the R&D department, projects and our own laboratory.

Prilux est une entreprise espagnole avec plus de 35 ans d'expérience dans le secteur de l'éclairage.

Chez Prilux nous nous efforçons jour après jour d'être l'un des leaders mondiaux de l'éclairage en offrant au marché la haute technologie de l'éclairage avec un rapport qualité / prix imbattable et des conseils personnalisés à nos clients sur leurs projets en offrant un service plus efficace.

Nous sommes une équipe jeune, dynamique et multidisciplinaire composée de plus de 200 professionnels, parmi lesquels plus de 20 ingénieurs font partie du département R&D, des projets et de notre propre laboratoire.

A Prilux é uma empresa espanhola com mais de 35 anos de experiência no setor da iluminação.

Na Prilux esforçamo-nos dia após dia para ser uma das empresas líderes mundiais em iluminação, oferecendo ao mercado alta tecnologia em iluminação com uma relação qualidade / preço imbatível e um aconselhamento personalizado aos nossos clientes nos seus projectos, oferecendo um serviço mais eficaz.

Somos uma equipa jovem, dinâmica e multidisciplinar composta por mais de 200 profissionais, entre os quais mais de 20 engenheiros fazem parte do departamento de I&D, projectos e laboratório próprio.



Producción y Calidad

Production and quality

Production et qualité

Produção e Qualidade

Todos nuestros módulos LED se fabrican dentro de nuestras propias instalaciones, contando con una "Sala Blanca" equipada con una línea automática de montaje de componentes SMD (Serigrafía - Pick & Place - Horno). Diseñamos nuestras propias PCB a partir de las cuales fabricamos los módulos destinados a las soluciones lumínicas "Made in Spain".

Nuestros procesos de producción están completamente informatizados lo que nos permite llevar un exhaustivo control de calidad y una total trazabilidad del producto en cualquiera de sus etapas de fabricación cumpliendo siempre, la normativa vigente.

All our LED modules are manufactured within our own facilities, which include a "White Room" equipped with an automatic assembly line of SMD components (Screen printing - Pick & Place - Furnace). We design our own PCBs, WITH which we manufacture the modules aimed at the "Made in Spain" lighting solutions.

Our production processes are totally computerised, enabling a thorough quality control and the comprehensive traceability of the product in any stage of production, always in compliance with the required standards.

Tous nos modules LED sont fabriqués dans nos propres installations et nous disposons d'une « salle blanche » équipée d'une ligne automatique de montage de composants SMD (sérigraphie - pick & place - four). Nous concevons nos propres PCB à partir desquels nous fabriquons les modules destinés aux solutions d'éclairage « Made in Spain ».

Nos processus de production sont entièrement automatisés, ce qui nous permet de réaliser un contrôle de qualité exhaustif et une traçabilité totale du produit à n'importe quelle étape de fabrication, en respectant toujours la réglementation en vigueur.

Todos os nossos módulos LED são fabricados dentro das nossas próprias instalações, para isso dispomos de uma "Sala Branca" equipada com uma linha automática de montagem de componentes SMD (Serigrafia - Pick & Place - Forno). Desenhamos as nossas próprias PCB a partir das quais fabricamos os módulos destinados às soluções lumínicas "Made in Spain".

Os nossos processos de produção estão completamente informatizados o que nos permite chegar a um exaustivo controlo de qualidade e a uma total leitura do percurso do produto em qualquer das suas etapas de fabrico cumprindo sempre, a normativa em vigor.

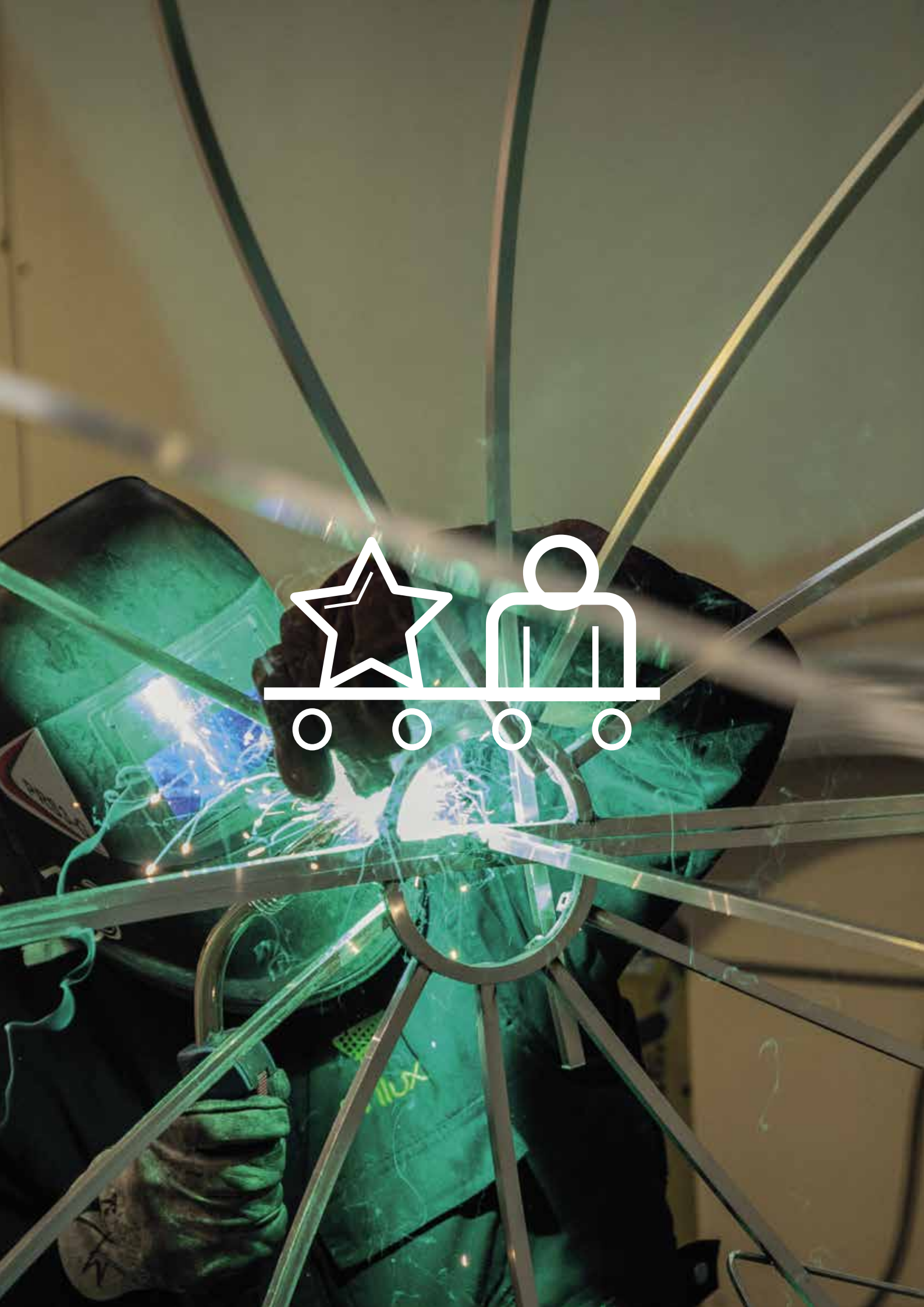

Hacemos realidad tus ideas

Production and quality

Production et qualité

Produção e Qualidade



IDEACIÓN DE LA CAMPAÑA

CAMPAIGN BRAINSTORMING
IDEATION DE LA CAMPAGNE
IDEAÇÃO DA CAMPANHA

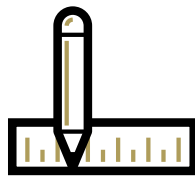

PROYECTOS

PROJECTS
PROJETS
PROJETOS

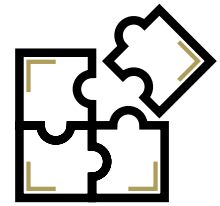

MONTAJE

MOUNTING
ASSEMBLAGE
MONTAGEM



FASE COMERCIAL

COMMERCIAL STEP
PHASE COMMERCIALE
FASE COMERCIAL

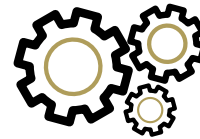

FABRICACIÓN

MANUFACTURING
FABRICATION
FABRICAÇÃO

En PRILUX diseñamos y producimos el 100% de los motivos en nuestras instalaciones de Toledo garantizando, su alta calidad y el cumplimiento de los plazos de entrega. Esto nos permite ofrecer la posibilidad, bajo pedido, de personalización de motivos adaptados totalmente a las necesidades y exigencias del cliente.

Nuestro departamento de Proyectos realiza simulaciones de decoraciones a partir de fotografías en las que se personalizan las decoraciones según las tendencias o directrices que nos marque el cliente. Proporcionamos asesoramiento, apoyo y orientación técnica adecuada para la obtención del mejor proyecto decorativo.

In PRILUX we design and manufacture 100% of the lighting motifs in our facilities in Toledo, ensuring not only high quality but also meeting the most challenging deadlines. We offer the possibility, on demand, of customizing and adapt the motif to any kind of demands and needs from the customer.

For this purpose, our Project Department carries out simulations of decorations from photographs in which, according to the last trends and client's guidelines, we customize all the motif. Moreover, we provide to our customers a good piece of advice, support and guidance to get the best decorative project.

À PRILUX nous concevons et fabriquons le 100% des motifs lumineux dans nos installations à Tolède, assurant non seulement de haute qualité, mais aussi le respect des délais les plus serrés. Nous offrons la possibilité, sur demande, de personnaliser et adapter les motifs à tout type de demandes et besoins de nos clients.

A cet effet, notre Département du Projet réalise des simulations de décorations à partir de photographies dans lesquelles, selon les dernières tendances et les directives du client, nous personnalisons toutes les motifs. De plus, nous offrons à nos clients des conseils et du soutien pour obtenir le meilleur projet décoratif.

Em PRILUX projetamos e fabricamos o 100% dos motivos de iluminação nas nossas instalações de Toledo, garantindo não só uma alta qualidade, mas também o cumprimento dos prazos mais exigentes. Oferecemos a possibilidade, sob demanda, de personalizar e adaptar o motivo para qualquer tipo de exigências e necessidades do cliente.

Para este efeito, o nosso Departamento de Projetos realiza simulações de decorações de fotografias em que, de acordo com as últimas tendências e diretrizes do cliente, nós personalizar todo o motivo. Além disso, nós fornecemos aos nossos clientes aconselhamento, apoio e orientação para obter o melhor projeto decorativo.





Flexilight



Rota -
Cádiz

flexiLIGHT LED



						$\frac{W}{\%}$	W			P.V.P.
952750			1m	13mm	36	3W	135W	Máx.90m	Rollo 45m	205,50€
995078			1m	13mm	36	3W	135W	Máx.90m	Rollo 45m	205,50€
995085			1m	13mm	36	3W	135W	Máx.90m	Rollo 45m	225,50€
952767			1m	13mm	36	3W	135W	Máx.90m	Rollo 45m	205,50€
952781			1m	13mm	36	3W	135W	Máx.90m	Rollo 45m	225,50€
952774			1m	13mm	36	3W	135W	Máx.90m	Rollo 45m	190,50€
952798			1m	13mm	36	3W	135W	Máx.90m	Rollo 45m	190,50€
191814			1m	13mm	36	3W	135W	Máx.90m	Rollo 45m	225,50€
191807			1m	13mm	36	3W	135W	Máx.90m	Rollo 45m	225,50€
952811			1m	13mm	36	3W	135W	Máx.90m	Rollo 45m	360,00€
961158			1m	13mm	36	3W	135W	Máx.90m	Rollo 45m	360,00€
150316			1m	13mm	36	3W	135W	Máx.90m	Rollo 45m	205,50€

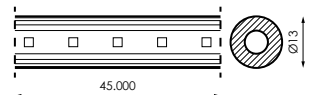

	230V ac		CII
	1 CANAL/ 2 VÍAS		
	IP44 PLUG		360°
	IP65		INC.



Ciudad de Braga 2020
by AM Illumination
Producto Prilux

flexiLIGHT LED Flashing

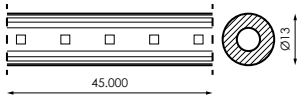

				\varnothing		W/%	W			P.V.P.	
484190			1,5m	13mm	30+6 flash	3,5W	105W	Máx.90m	Rollo 45m	285,00€	
970853			1,5m	13mm	30+6 flash	3,5W	105W	Máx.90m	Rollo 45m	304,50€	
953368			1,5m	13mm	30+6 flash	3,5W	105W	Máx.90m	Rollo 45m	285,00€	
386944			1,5m	13mm	30+6 flash	3,5W	105W	Máx.90m	Rollo 45m	285,00€	
386951			1,5m	13mm	30+6 flash	3,5W	105W	Máx.90m	Rollo 45m	304,50€	
386968			1,5m	13mm	30+6 flash	4,2W	125W	Máx.90m	Rollo 45m	257,25 €	
386975			1,5m	13mm	30+6 flash	4,2W	125W	Máx.90m	Rollo 45m	257,25 €	
386982			1,5m	13mm	30+6 flash	3,5W	105W	Máx.90m	Rollo 45m	445,00€	
386999			1,5m	13mm	30+6 flash	3,5W	105W	Máx.90m	Rollo 45m	445,00€	

⚡ 230V ac □ CII

👁️ 1 CANAL/ 2 VÍAS

🔌 IP44 PLUG ⚡ 360°

🌧️ IP65 ⚡ INC.

CABLE ALIMENTACIÓN Ø13mm

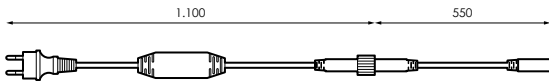

			W				P.V.P.
952828			230Vac Max. 480W	CII	IP44 Plug IP65 Conector	10	9,50€
150330			230Vac Max. 480W	CII	IP44 Plug IP65 Conector	10	9,50€

EMPALME ESTANCO Ø13mm

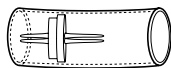

		P.V.P.
010818	25	1,55 €

CLIP SUJECCIÓN



			P.V.P.
446761	Flexilight 13mm	100	0,29€

TAPA FINAL Ø13mm

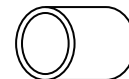

		P.V.P.
011853	25	0,20€



CC As Cancelas -
Santiago de Compostela

flexiLIGHT LED RGB

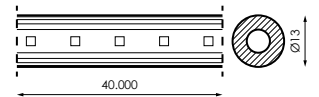

							W			P.V.P.
546676			1m	13mm	36	4,6W	184W	Máx.55m	Rollo 40m	520,00€

	230V dc		CII
	IP65		360°
	NO INC.		NO INC.

ADAPTADOR SMART LINK - FLEXILIGHT

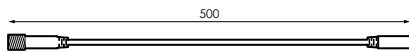

				P.V.P.
192477		IP65	5	7,50€
192453		IP65	5	7,50€

Termoretractil y conector macho **NO INCLUIDOS**
Heat-shrinkable and male connector **NOT INCLUDED**
Thermorétractable et connecteur mâle **NON INCLUS**
Tubo de contração térmica e conector macho **NÃO INCLuíDO**

CONTROLADOR RGB CON MANDO

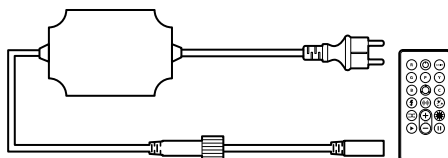

			W		P.V.P.
547239	230V	IP55	Max. 2.000leds	10	32,00€

Adaptador **INCLUIDO**. Efecto memoria.
Adapter **INCLUDED**. Memory effect.
Adaptateur **INCLUS**. Effet mémoire.
Adaptador **INCLuíDO**. Efeito de memória.

CONTROLADOR POWER LINE RGB

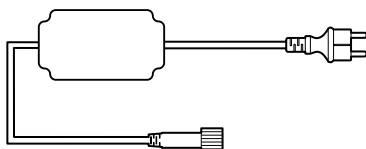

			W		P.V.P.
486262	230V	IP55	Max. 2.000leds	5	28,50€

Sincronización coordinada mediante una línea eléctrica. Cambio secuencial cada 15seg.
Coordinated synchronization through an electrical panel. Sequential change every 15sec.
Synchronisation coordonnée via un tableau électrique. Changement séquentiel toutes les 15s.
Sincronização coordenada através de um painel elétrico. Mudança sequencial a cada 15seg.

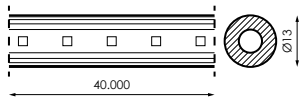

flexiLIGHT LED CW/WW



⚡ 230V dc	□ CII
☁ IP65	△ 360°
⊠ NO INC.	⊠ NO INC.

	💡	⊗	✂	∅	⚡	W%	W	⊞	⊞	P.V.P.
486347	LED	5VDC	1m	13mm	36	4,6W	184W	Máx.55m	Rollo 40m	520,00€

ADAPTADOR SMART LINK - FLEXILIGHT

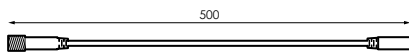

	⊗	☁	⊞	P.V.P.
192477	☀	IP65	5	7,50€
192453	👁	IP65	5	7,50€

Termoretractil y conector macho **NO INCLUIDOS**
 Heat-shrinkable and male connector **NOT INCLUDED**
 Thermorétractable et connecteur mâle **NON INCLUS**
 Tubo de contração térmica e conector macho **NÃO INCLUIDO**

CONTROLADOR CW-WW CON MANDO

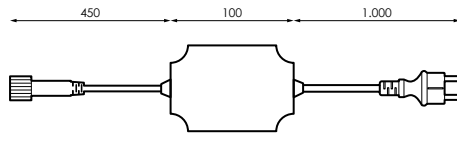

	⚡	☁	W	⊞	P.V.P.
486309	230V	IP55	Max. 2.000leds	5	32,00€

Efecto memoria
 Memory effect
 Effet mémoire
 Efeito de memória

CONTROLADOR POWER LINE CW-WW

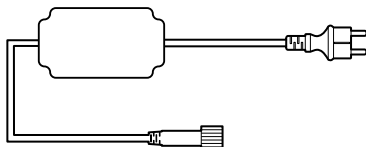

	⚡	☁	W	⊞	P.V.P.
486323	230V	IP55	Max. 2.000leds	5	28,50€

Sincronización coordinada mediante una línea eléctrica. Cambio secuencial cada 15seg.
 Coordinated synchronization through an electrical panel. Sequential change every 15sec.
 Synchronisation coordonnée via un tableau électrique. Changement séquentiel toutes les 15s.
 Sincronização coordenada através de um painel elétrico. Mudança sequencial a cada 15seg.



flexiLIGHT LED Mini Neon

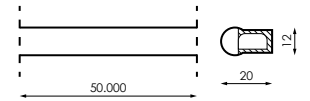

Barcode	LED	PVC	Length	Width	LED Density	Power/W	Max Power/W	Max Length	Roll Length	P.V.P.
546331	LED	PVC	1m	12x20mm	120	9W	450W	Máx.50m	Rollo 50m	350,00€
546348	LED	PVC	1m	12x20mm	120	9W	450W	Máx.50m	Rollo 50m	350,00€

⚡	230V ac	□	CII
👁️	1 CANAL/ 2 VÍAS		
🔌	IP44 PLUG	⚡	360°
🔌	IP65	⚡	INC.

CABLE ALIMENTACIÓN MINI NEON

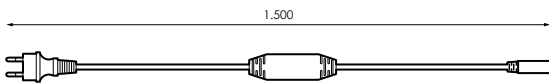

Barcode	LED	⚡	🔌	📦	P.V.P.
546430	LED	230Vac/dc	IP44 Plug IP54 Conector	5	9,80€

EMPALME MINI NEON

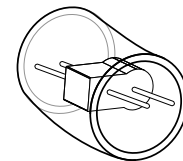

Barcode	LED	📦	P.V.P.
546447	BI	Blanco	100 1,55€

CLIP SUJECCIÓN MINI NEON

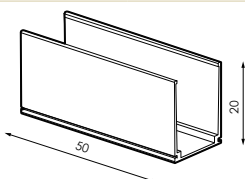

Barcode	LED	📦	P.V.P.
546461	A	Aluminio	100 0,50€

TAPA FINAL MINI NEON

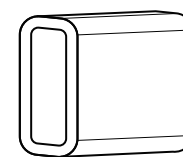

Barcode	LED	📦	P.V.P.
546454	T	Transparente	100 0,20€



flexiLIGHT LED Double Neon

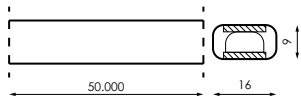

							$W/\%$	W			P.V.P.
546379				1m	9x16mm	120	9W	450W	Máx.50m	Rollo 50m	350,00€
546386				1m	9x16mm	120	9W	450W	Máx.50m	Rollo 50m	350,00€
481564				1m	9x16mm	120	9W	450W	Máx.50m	Rollo 50m	350,00€
481571				1m	9x16mm	120	9W	450W	Máx.50m	Rollo 50m	350,00€
481588				1m	9x16mm	120	9W	450W	Máx.50m	Rollo 50m	350,00€
481595				1m	9x16mm	120	9W	450W	Máx.50m	Rollo 50m	400,00€

	230V ac		CII
	1 CANAL/ 2 VÍAS		
	IP44 PLUG		360°
	IP65		INC.

CABLE ALIMENTACIÓN DOUBLE NEON

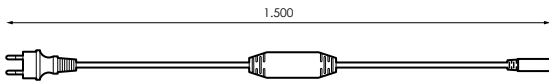

					P.V.P.
546515		230Vac/dc	IP44 Plug IP65 Conector	5	9,80€

CLIP SUJECCIÓN DOUBLE NEON

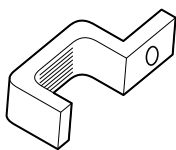

			P.V.P.
546546		T Transparente	100 0,50€

EMPALME DOUBLE NEON

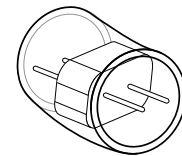

			P.V.P.
546522		Blanco	100 1,55€

TAPA FINAL DOUBLE NEON

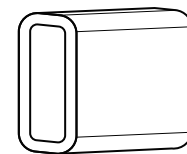

			P.V.P.
546539		T Transparente	100 0,20€



flexiLIGHT LED Brite



						$\frac{W}{\%}$	W			P.V.P.
442688			1m	11x6mm	60	5,5W	275W	Máx.100m	Rollo 50m	210,00€
442671			1m	11x6mm	60	5,5W	275W	Máx.100m	Rollo 50m	210,00€
442695			1m	11x6mm	60	5,5W	275W	Máx.100m	Rollo 50m	210,00€
563345*			1m	11x6mm	60	5,5W	275W	Máx.100m	Rollo 50m	210,00€
563321*			1m	11x6mm	60	5,5W	275W	Máx.100m	Rollo 50m	210,00€

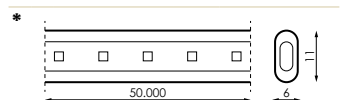
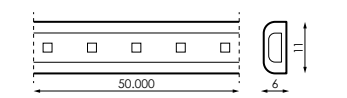

230V ac CII

1 CANAL/ 2 VÍAS

IP44 PLUG 120°

IP65 INC.

CABLE ALIMENTACIÓN BRITE

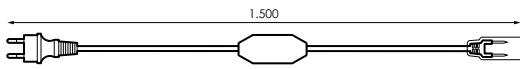

			W			P.V.P.
442701		230Vac	Max. 480W	IP44 Plug	IP66 Conector	5 9,50€

EXTENSIÓN BRITE

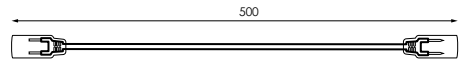

			P.V.P.
442787	BI Blanco	10	3,70€

ADAPTADOR SMART LINK-FLEXILIGHT BRITE

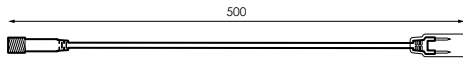

			P.V.P.
442800	BI Blanco	10	7,50€

ADAPTADOR FLEXILIGHT BRITE-SMART LINK

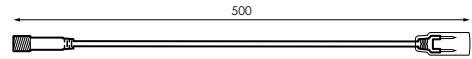

			P.V.P.
442817	BI Blanco	10	7,50€

CLIP SUJECCIÓN BRITE

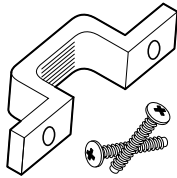

			P.V.P.
442749	T Transparente	100	0,27€

CANALETA BRITE



				P.V.P.
442756	1m	T Transparente	1	1,80€

CONECTOR L BRITE

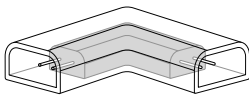

			P.V.P.
442763	T Transparente	10	2,00€

CONECTOR X BRITE

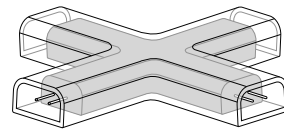

			P.V.P.
442770	T Transparente	10	4,50€

EMPALME SENCILLO BRITE

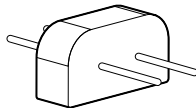

			P.V.P.
442725	T Transparente	100	1,00€

CONECTOR MACHO BRITE

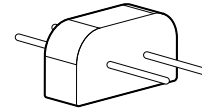

			P.V.P.
442718	T Transparente	100	1,00€

EMPALME ESTANCO BRITE

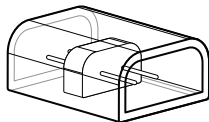

			P.V.P.
442732	T Transparente	100	1,60€

TAPA FINAL BRITE

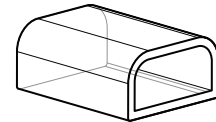

			P.V.P.
442794	T Transparente	100	0,26€

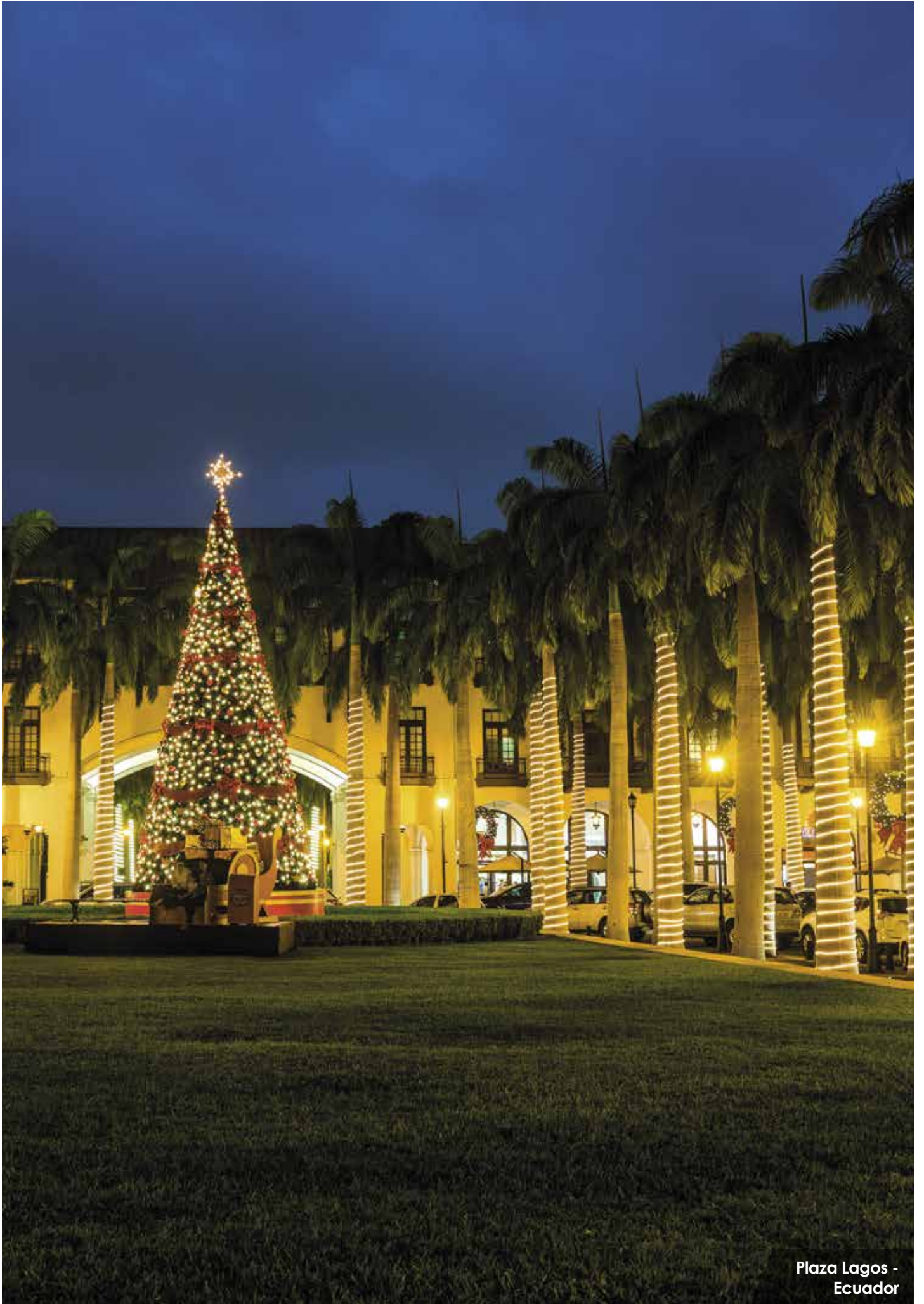

Plaza Lagos -
Ecuador

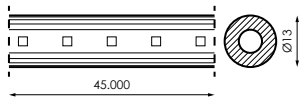

flexiLIGHT Instant



⚡ 230V ac	□ CII
🗣️ 1 CANAL/ 2 VÍAS	
IP44 PLUG	⚡ 120°
IP65	🔌 INC.

Barcode	Light Icon	Material	Length	Ø	LEDs	W/LED	W	Max. Length	Roll	P.V.P.
002684	🔆	PVC	1m	13mm	36	16,56W	828W	Máx.100m	Rollo 50m	140,00€
002691	🔆	PVC	1m	13mm	36	16,56W	828W	Máx.100m	Rollo 50m	140,00€
002714	🔆	PVC	1m	13mm	36	16,56W	828W	Máx.100m	Rollo 50m	140,00€
002721	🔆	PVC	1m	13mm	36	16,56W	828W	Máx.100m	Rollo 50m	140,00€
002707	🔆	PVC	1m	13mm	36	16,56W	828W	Máx.100m	Rollo 50m	140,00€
002738	🔆	PVC	1m	13mm	36	16,56W	828W	Máx.100m	Rollo 50m	140,00€

CABLE ALIMENTACIÓN Ø13mm

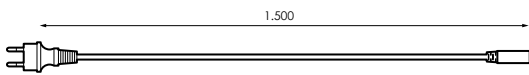

Barcode	Material	Voltage	Roll	P.V.P.
096744	PVC	230Vac	5	5,25€

CLIP SUJECCIÓN



Barcode	Material	Roll	P.V.P.
446761	Flexilight 13mm	100	0,29€

EMPALME ESTANCO Ø13mm

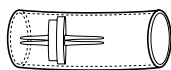

Barcode	Roll	P.V.P.
010818	25	1,55 €

TAPA FINAL Ø13mm

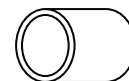

Barcode	Roll	P.V.P.
011853	25	0,20€



Led Exterior

Outdoors Led
Led à l'exterieur
Led ao ar livre



STRING **PLUS** 180 Cápsula Clara



									W			P.V.P.
995108				12m	4m (x3seg.)	180	60	3W	10W	100m	10	50,00€
163651				12m	4m (x3seg.)	180	60	3W	10W	100m	10	50,00€
995115				12m	4m (x3seg.)	180	60	3W	10W	100m	10	52,00€
995122				12m	4m (x3seg.)	180	60	3W	10W	100m	10	52,00€
546577				12m	4m (x3seg.)	180	60	3W	10W	100m	10	52,00€
546584				12m	4m (x3seg.)	180	60	3W	10W	100m	10	52,00€
163477				12m	4m (x3seg.)	180	60	3W	10W	100m	10	50,00€
477987				12m	4m (x3seg.)	180	60	3W	10W	100m	10	50,00€
477949				12m	4m (x3seg.)	180	60	3W	10W	100m	10	52,00€
163507				12m	4m (x3seg.)	180	60	3W	10W	100m	10	52,00€
163491				12m	4m (x3seg.)	180	60	3W	10W	100m	10	49,00€
542227				12m	4m (x3seg.)	180	60	3W	10W	100m	10	49,00€
530293				12m	4m (x3seg.)	180	60	3W	10W	100m	10	52,00€
163514				12m	4m (x3seg.)	180	60	3W	10W	100m	10	49,00€
477932				12m	4m (x3seg.)	180	60	3W	10W	100m	10	50,00€
388153				12m	4m (x3seg.)	180	60	3W	10W	100m	10	56,00€
388160				12m	4m (x3seg.)	180	60	3W	10W	100m	10	56,00€

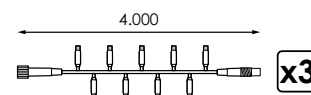

- 230V dc CII
- 1 CANAL IP65
- NO INC. SMART LINK



CC, As Cancelas -
Santiago de Compostela



STRING **PLUS** 180 FLASHING Cápsula Clara

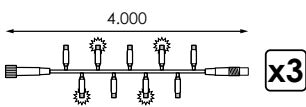

Barcode	LED Type	Light Icon	Length	Segment Length	LEDs per Segment	Flashing Mode	Power (W)	Weight (kg)	Length (m)	Quantity	P.V.P.
542357	LED	White	12m	4m (x3seg.)	180	50+10 flashing	3W	11W	100m	10	57,00€
542364	LED	Green	12m	4m (x3seg.)	180	50+10 flashing	3W	11W	100m	10	57,00€
995146	LED	Green	12m	4m (x3seg.)	180	50+10 flashing	3W	11W	100m	10	58,00€
977647	LED	White	12m	4m (x3seg.)	180	50+10 flashing	3W	11W	100m	10	58,00€
542388	LED	Blue	12m	4m (x3seg.)	180	50+10 flashing	3W	11W	100m	10	57,00€
542395	LED	Red	12m	4m (x3seg.)	180	50+10 flashing	3W	11W	100m	10	54,00€
542371	LED	Green	12m	4m (x3seg.)	180	50+10 flashing	3W	11W	100m	10	58,00€
542401	LED	White	12m	4m (x3seg.)	180	50+10 flashing	3W	11W	100m	10	66,00€
542418	LED	White	12m	4m (x3seg.)	180	50+10 flashing	3W	11W	100m	10	66,00€
512886	LED	White	12m	4m (x3seg.)	180	50+10 flashing	3W	11W	100m	10	58,00€

- 230V dc
- CII
- 1 CANAL
- IP65
- NO INC.
- SMART LINK

CABLE ALIMENTACIÓN SMART LINK

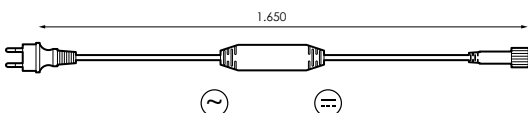

Barcode	Light Icon	Voltage	Power	Plug Type	Quantity	P.V.P.
995092	White	230Vac	Max. 480W	CII IP44 Plug IP65 Conector	10	9,50€
977722	White	230Vac	Max. 480W	CII IP44 Plug IP65 Conector	10	9,50€



Los Silos -
Santa Cruz de Tenerife

STRING PLUS 100

Serie Minimalist



Barcode	LED	Waterproof	Length	Segment	Light Type	Light Count	Power	Power	Length	Connectors	P.V.P.
546690	LED	Waterproof	10m	5m (x 2seg.)	100	50	4W	8W	100m	10	32,00€
546706	LED	Waterproof	10m	5m (x 2seg.)	100	50	4W	8W	100m	10	32,00€
546713	LED	Waterproof	10m	5m (x 2seg.)	100	50	4W	8W	100m	10	35,00€
546720	LED	Waterproof	10m	5m (x 2seg.)	100	50	4W	8W	100m	10	35,00€
546737	LED	Waterproof	10m	5m (x 2seg.)	100	50	4W	8W	100m	10	32,00€
546744	LED	Waterproof	10m	5m (x 2seg.)	100	50	4W	8W	100m	10	35,00€
546751	LED	Waterproof	10m	5m (x 2seg.)	100	50	4W	8W	100m	10	30,00€
546768	LED	Waterproof	10m	5m (x 2seg.)	100	50	4W	8W	100m	10	30,00€
546775	LED	Waterproof	10m	5m (x 2seg.)	100	50	4W	8W	100m	10	40,00€
546782	LED	Waterproof	10m	5m (x 2seg.)	100	50	4W	8W	100m	10	40,00€

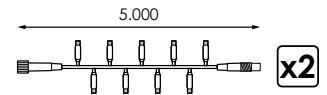

⚡	230V dc	☐	CII
🗣️	1 CANAL	🌫️	IP65
🚫	NO INC.	SMART LINK	

STRING PLUS 100 FLASHING

Serie Minimalist



Barcode	LED	Waterproof	Length	Segment	Light Type	Light Count	Power	Power	Length	Connectors	P.V.P.
546799	LED	Waterproof	10m	5m (x 2seg.)	100	40+10 flashing	4W	8W	100m	10	36,00€
546805	LED	Waterproof	10m	5m (x 2seg.)	100	40+10 flashing	4W	8W	100m	10	36,00€
546812	LED	Waterproof	10m	5m (x 2seg.)	100	40+10 flashing	4W	8W	100m	10	39,50€
546829	LED	Waterproof	10m	5m (x 2seg.)	100	40+10 flashing	4W	8W	100m	10	39,50€

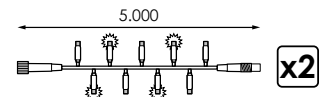

⚡	230V dc	☐	CII
🗣️	1 CANAL	🌫️	IP65
🚫	NO INC.	SMART LINK	

CABLE ALIMENTACIÓN SMART LINK

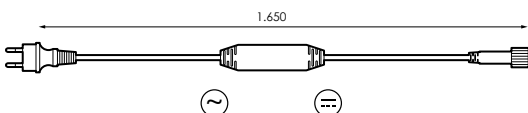

Barcode	Waterproof	Power	Power	Connectors	Connectors	P.V.P.
995092	Waterproof	230Vac	Max. 480W	☐	IP44 Plug IP65 Conector	10 9,50€
977722	Waterproof	230Vac	Max. 480W	☐	IP44 Plug IP65 Conector	10 9,50€



Plaza Navarra -
Huesca

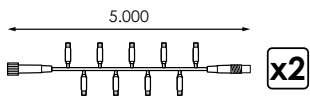

STRING **PLUS** 100 RGB



230V dc	CII
1 CANAL	IP65
NO INC.	SMART LINK

												P.V.P.
571814				10m	5m (x2seg.)	100	50	4,6W	9,2W	100m	10	57,00€
571821				10m	5m (x2seg.)	100	50	4,6W	9,2W	100m	10	57,00€

CONTROLADOR RGB CON MANDO

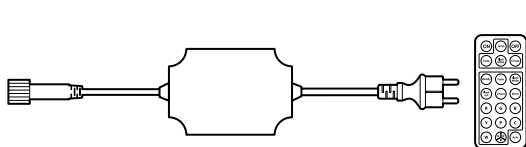

						P.V.P.
571845		230V	IP55	Max. 2.000leds	10	32,00€

Efecto memoria.
Memory effect.
Effet mémoire.
Efeito de memória.



STRING **PLUS** 100 CW/WW

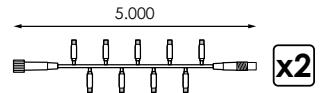

	Barcode	LED	Beam	Length	Segment	Light	Light	W	W	Beam	Beam	P.V.P.
486286				10m	5m (x2seg.)	100	50	5,3W	10,6W	100m	10	59,00€
486293				10m	5m (x2seg.)	100	50	5,3W	10,6W	100m	10	59,00€

	230V dc		CII
	1 CANAL		IP65
	NO INC.		SMART LINK

CONTROLADOR CW-WW CON MANDO

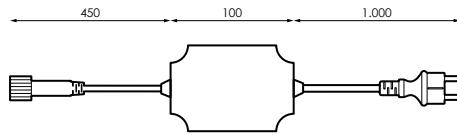

Barcode	Lightning bolt	IP	W	Beam	P.V.P.
486309	230V	IP55	Max. 2.000leds	5	32,00€

Efecto memoria
Memory effect
Effet mémoire
Efeito de memória

CONTROLADOR POWER LINE CW-WW

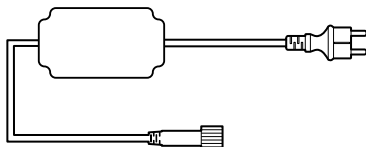

Barcode	Lightning bolt	IP	W	Beam	P.V.P.
486323	230V	IP55	Max. 2.000leds	5	28,50€

Sincronización coordinada mediante una línea eléctrica. Cambio secuencial cada 15seg.
Coordinated synchronization through an electrical panel. Sequential change every 15sec.
Synchronisation coordonnée via un tableau électrique. Changement séquentiel toutes les 15s.
Sincronização coordenada através de um painel elétrico. Mudança sequencial a cada 15seg.

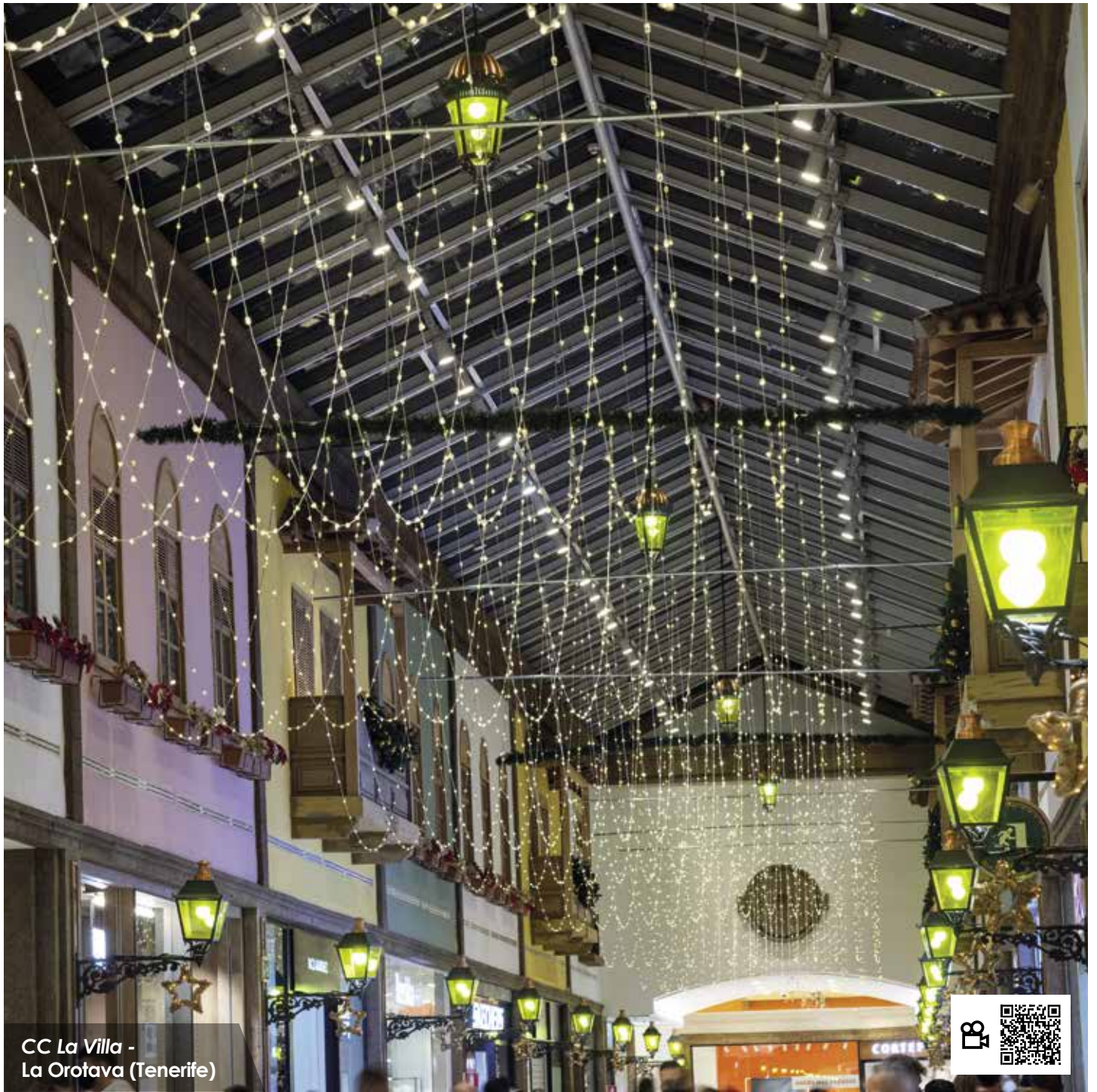

CC La Villa -
La Orotava (Tenerife)



[GRÁFICOS: Unidades en mm/ GRAPHICS: Units in mm/ GRÁFICOS: Unidades em mm]

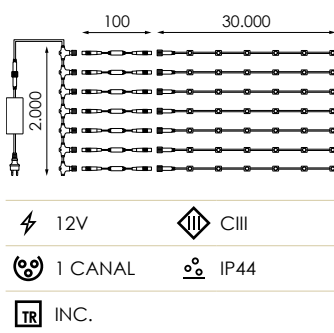

Techo de Luz



								W			P.V.P.
546621				2x30m	7	693	99	115W	NO empalmable	1	645,00€
546614				2x30m	7	693	99	115W	NO empalmable	1	645,00€
391375				2x30m	7	693	88+11 flashing	115W	NO empalmable	1	655,00€
391382				2x30m	7	693	88+11 flashing	115W	NO empalmable	1	655,00€

PROTECTOR SOBRETENSIONES

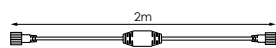

		P.V.P.
499507	1	8,00€



Clinica San Miguel - Pamplona

SCREENLIGHT



Barcode	LED	Light Type	Beam Spread	Length	Series	Beam Angle	Spacer	W	Sets	Accessories	P.V.P.
953108	LED	Point	2x	1,5m	20 (2 tiras = 1 serie)	300	15	30W	10 sets	5	132,00€
995177	LED	Point	2x	1,5m	20 (2 tiras = 1 serie)	300	15	30W	10 sets	5	137,50€
995184	LED	Point	2x	1,5m	20 (2 tiras = 1 serie)	300	15	30W	10 sets	5	137,50€
953115	LED	Point	2x	1,5m	20 (2 tiras = 1 serie)	300	15	30W	10 sets	5	132,00€
953153	LED	Point	2x	3m	20 (2 tiras = 1 serie)	600	30	35W	7 sets	2	214,50€
995191	LED	Point	2x	3m	20 (2 tiras = 1 serie)	600	30	35W	7 sets	2	220,00€
995207	LED	Point	2x	3m	20 (2 tiras = 1 serie)	600	30	35W	7 sets	2	220,00€
163712	LED	Point	2x	3m	20 (2 tiras = 1 serie)	600	30	35W	7 sets	2	214,50€
953177	LED	Point	2x	6m	20	1200	60	74W	3 sets	2	374,00€
163569	LED	Point	2x	6m	20	1200	60	74W	3 sets	2	396,00€
163576	LED	Point	2x	6m	20	1200	60	74W	3 sets	2	396,00€
092609	LED	Point	2x	6m	20	1200	60	74W	3 sets	2	363,00€
953191	LED	Point	2x	9m	20	1800	90	150W	NO empalmable	1	544,50€
146241	LED	Point	2x	9m	20	1800	90	150W	NO empalmable	1	555,00€

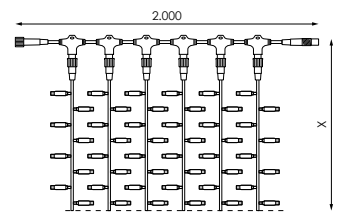

- ⚡ 230V dc □ CII
- 🔊 1 CANAL 🌫️ IP65
- ⚡ NO INC. SMART LINK



Escatrón - Zaragoza

SCREENLIGHT FLASHING

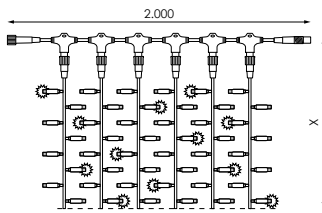

								W			P.V.P.
146258				2x1,5m	20 (2 tiras = 1 serie)	300	13+2 flashing	30W	10 sets	5	152,00€
146456				2x1,5m	20 (2 tiras = 1 serie)	300	13+2 flashing	30W	10 sets	5	157,30€
163606				2x3m	20 (2 tiras = 1 serie)	600	26+4 flashing	35W	7 sets	2	253,00€
146555				2x3m	20 (2 tiras = 1 serie)	600	26+4 flashing	35W	7 sets	2	264,00€
163613				2x6m	20	1200	54+6 flashing	73W	3 sets	2	418,00€
146562				2x6m	20	1200	54+6 flashing	73W	3 sets	2	434,50€
441698				2x9m	20	1800	80+10 flashing	150W	NO empalmable	1	599,50€
441704				2x9m	20	1800	80+10 flashing	150W	NO empalmable	1	610,50€

230V dc CII

1 CANAL IP65

NO INC. SMART LINK

CABLE ALIMENTACIÓN SMART LINK

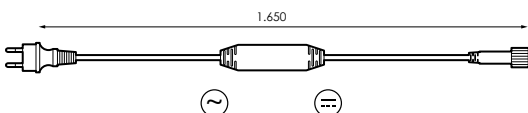

			W				P.V.P.
995092		230Vac	Max. 480W	CII	IP44 Plug IP65 Conector	10	9,50€
977722		230Vac	Max. 480W	CII	IP44 Plug IP65 Conector	10	9,50€



Los Silos -
Santa Cruz de Tenerife

SCREENLIGHT

Serie Minimalist



Barcode	LED	Light Type	Length	LEDs	N°	Light Type	Beam Angle	W	Light Type	Light Type	P.V.P.
503969	LED	Spot	2x1m	20	2	100	5	7,7W	10 sets	10	66,00€
503976	LED	Spot	2x1m	20	2	100	5	7,7W	10 sets	10	68,00€
503990	LED	Spot	2x1,5m	20	4	150	7/8	15W	10 sets	10	85,00€
504003	LED	Spot	2x1,5m	20	4	150	7/8	15W	10 sets	10	89,00€
504010	LED	Spot	2x3m	20	4	300	15	18,4W	7 sets	10	150,00€
561471	LED	Spot	2x3m	20	4	300	15	18,4W	7 sets	10	160,00€
530347	LED	Spot	2x6m	20	4	600	30	42W	3 sets	10	260,00€
504133	LED	Spot	2x6m	20	4	600	30	42W	3 sets	10	270,00€
504027	LED	Spot	2x9m	20	4	900	45	70W	NO empalmable	1	360,00€
504034	LED	Spot	2x9m	20	4	900	45	70W	NO empalmable	1	369,00€

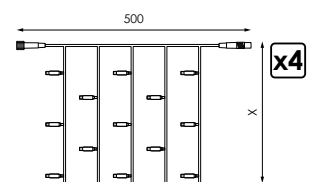
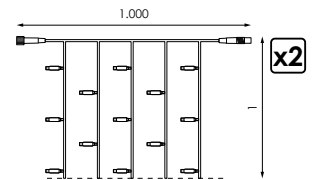

- ⚡ 230V dc □ CII
- 🔌 1 CANAL 🌐 IP65
- ⊗ NO INC. SMART LINK









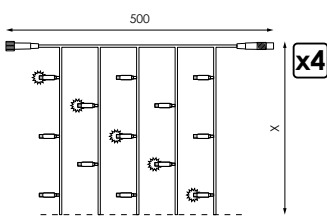



























Canet de Berenguer -
Valencia

SCREENLIGHT FLASHING

Serie Minimalist



									W			P.V.P.
504096				2x1,5m	20	4	150	5+2 flashing/ 6+2 flashing	15W	10 sets	10	98,00€
504102				2x1,5m	20	4	150	5+2 flashing/ 6+2 flashing	15W	10 sets	10	100,00€
504119				2x3m	20	4	300	12+3 flashing	18,4W	7 sets	10	175,00€
504126				2x3m	20	4	300	12+3 flashing	18,4W	7 sets	10	184,00€
504140				2x6m	20	4	600	24+6 flashing	42W	3 sets	10	300,00€
504157				2x6m	20	4	600	24+6 flashing	42W	3 sets	10	310,00€
504041				2x9m	20	4	900	36+9 flashing	70W	NO empalmable	1	390,00€
504058				2x9m	20	4	900	36+9 flashing	70W	NO empalmable	1	399,00€









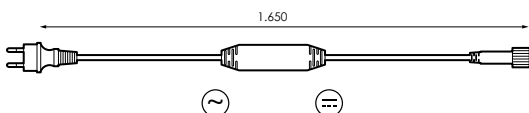

 230V dc  CII

 1 CANAL  IP65

 NO INC.  SMART LINK

CABLE ALIMENTACIÓN SMART LINK



				W				P.V.P.
995092			230Vac	Max. 480W	CII	IP44 Plug IP65 Conector	10	9,50€
977722			230Vac	Max. 480W	CII	IP44 Plug IP65 Conector	10	9,50€

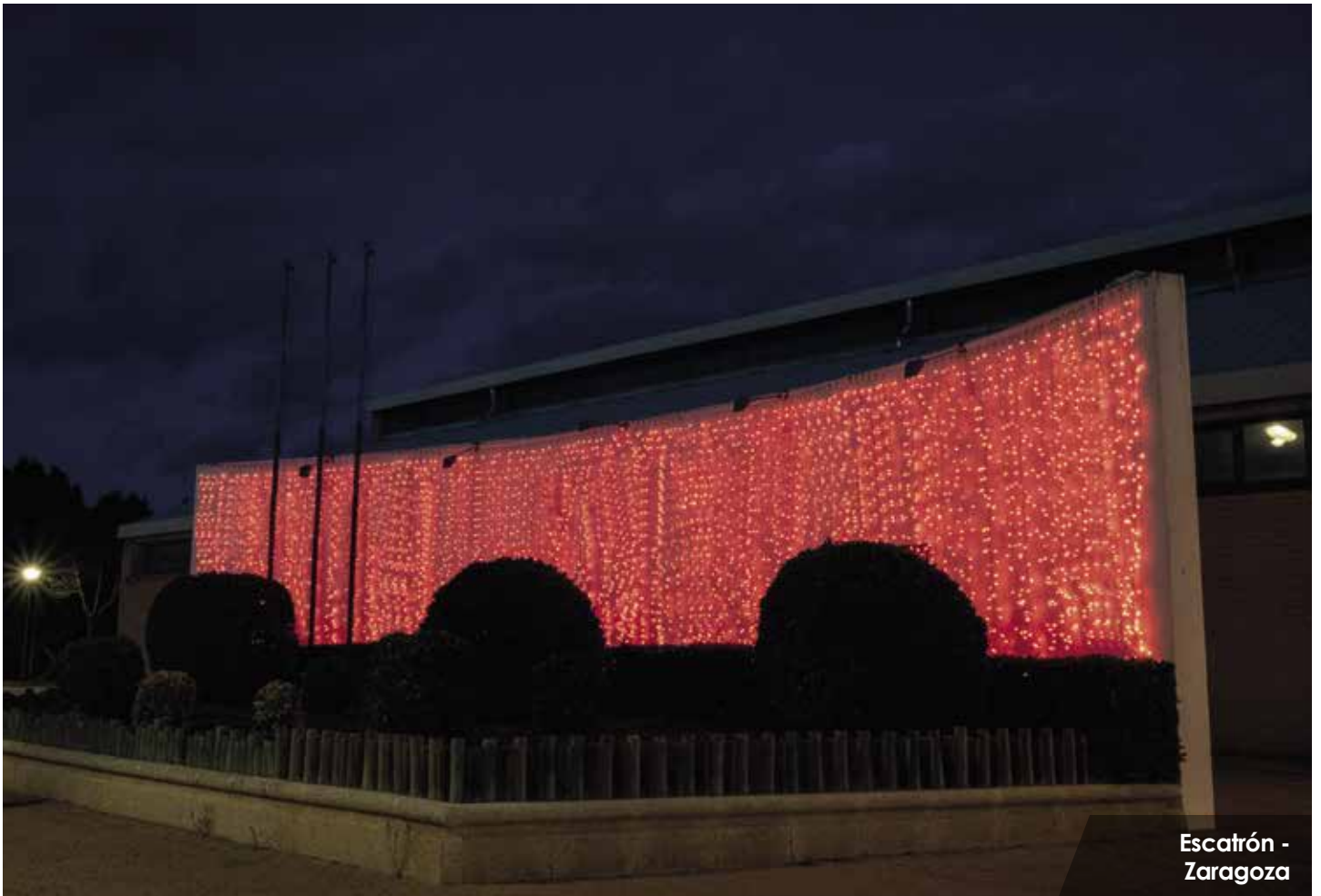

Escalón - Zaragoza

SCREENLIGHT 400 RGB

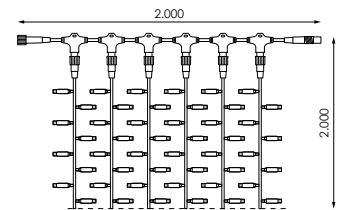

							W			P.V.P.
546652			2x2m	20 (2 tiras = 1 serie)	400	20	46W	5 sets	5	229,00€

	230V dc		CII
	1 CANAL		IP65
	NO INC.		SMART LINK

CONTROLADOR RGB CON MANDO

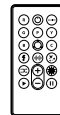
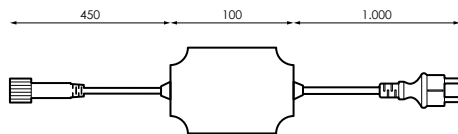

			W		P.V.P.
546683	230V	IP55	Max. 2.000leds	10	32,00€

Efecto memoria.
Memory effect.
Effet mémoire.
Efeito de memória.

CONTROLADOR POWER LINE RGB

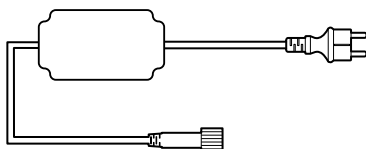

			W		P.V.P.
486262	230V	IP55	Max. 2.000leds	5	28,50€

Sincronización coordinada mediante una línea eléctrica. Cambio secuencial cada 15seg.
Coordinated synchronization through an electrical panel. Sequential change every 15sec.
Synchronisation coordonnée via un tableau électrique. Changement séquentiel toutes les 15s.
Sincronização coordenada através de um painel elétrico. Mudança sequencial a cada 15seg.



CC. Lagoh -
Sevilla

ICICLE

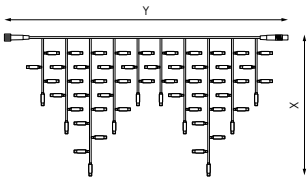

Barcode	LED	Light Icon	Eye Icon	Dimensions	Nº	Light Icon	Light Icon	W	Plug Icon	Box Icon	P.V.P.
977692	LED	Light Icon <td>Eye Icon <td>3x0,5m (1,5m x 2seg)</td> <td>2</td> <td>114</td> <td>57</td> <td>8W</td> <td>20 sets</td> <td>10</td> <td>57,00€</td> </td>	Eye Icon <td>3x0,5m (1,5m x 2seg)</td> <td>2</td> <td>114</td> <td>57</td> <td>8W</td> <td>20 sets</td> <td>10</td> <td>57,00€</td>	3x0,5m (1,5m x 2seg)	2	114	57	8W	20 sets	10	57,00€
146364	LED	Light Icon <td>Eye Icon <td>3x0,5m (1,5m x 2seg)</td> <td>2</td> <td>114</td> <td>57</td> <td>8W</td> <td>20 sets</td> <td>10</td> <td>59,00€</td> </td>	Eye Icon <td>3x0,5m (1,5m x 2seg)</td> <td>2</td> <td>114</td> <td>57</td> <td>8W</td> <td>20 sets</td> <td>10</td> <td>59,00€</td>	3x0,5m (1,5m x 2seg)	2	114	57	8W	20 sets	10	59,00€
163620	LED	Light Icon <td>Eye Icon <td>3x0,5m (1,5m x 2seg)</td> <td>2</td> <td>114</td> <td>57</td> <td>8W</td> <td>20 sets</td> <td>10</td> <td>59,00€</td> </td>	Eye Icon <td>3x0,5m (1,5m x 2seg)</td> <td>2</td> <td>114</td> <td>57</td> <td>8W</td> <td>20 sets</td> <td>10</td> <td>59,00€</td>	3x0,5m (1,5m x 2seg)	2	114	57	8W	20 sets	10	59,00€
163637	LED	Light Icon <td>Eye Icon <td>3x0,5m (1,5m x 2seg)</td> <td>2</td> <td>114</td> <td>57</td> <td>8W</td> <td>20 sets</td> <td>10</td> <td>56,00€</td> </td>	Eye Icon <td>3x0,5m (1,5m x 2seg)</td> <td>2</td> <td>114</td> <td>57</td> <td>8W</td> <td>20 sets</td> <td>10</td> <td>56,00€</td>	3x0,5m (1,5m x 2seg)	2	114	57	8W	20 sets	10	56,00€
163644	LED	Light Icon <td>Eye Icon <td>3x0,9m (1m x 3seg)</td> <td>3</td> <td>174</td> <td>58</td> <td>10,5W</td> <td>15 sets</td> <td>10</td> <td>84,00€</td> </td>	Eye Icon <td>3x0,9m (1m x 3seg)</td> <td>3</td> <td>174</td> <td>58</td> <td>10,5W</td> <td>15 sets</td> <td>10</td> <td>84,00€</td>	3x0,9m (1m x 3seg)	3	174	58	10,5W	15 sets	10	84,00€
163552	LED	Light Icon <td>Eye Icon <td>3x0,9m (1m x 3seg)</td> <td>3</td> <td>174</td> <td>58</td> <td>10,5W</td> <td>15 sets</td> <td>10</td> <td>88,50€</td> </td>	Eye Icon <td>3x0,9m (1m x 3seg)</td> <td>3</td> <td>174</td> <td>58</td> <td>10,5W</td> <td>15 sets</td> <td>10</td> <td>88,50€</td>	3x0,9m (1m x 3seg)	3	174	58	10,5W	15 sets	10	88,50€
161305	LED	Light Icon <td>Eye Icon <td>3x0,9m (1m x 3seg)</td> <td>3</td> <td>174</td> <td>58</td> <td>10,5W</td> <td>15 sets</td> <td>10</td> <td>88,50€</td> </td>	Eye Icon <td>3x0,9m (1m x 3seg)</td> <td>3</td> <td>174</td> <td>58</td> <td>10,5W</td> <td>15 sets</td> <td>10</td> <td>88,50€</td>	3x0,9m (1m x 3seg)	3	174	58	10,5W	15 sets	10	88,50€
543026	LED	Light Icon <td>Eye Icon <td>3x0,9m (1m x 3seg)</td> <td>3</td> <td>174</td> <td>58</td> <td>10,5W</td> <td>15 sets</td> <td>10</td> <td>82,00€</td> </td>	Eye Icon <td>3x0,9m (1m x 3seg)</td> <td>3</td> <td>174</td> <td>58</td> <td>10,5W</td> <td>15 sets</td> <td>10</td> <td>82,00€</td>	3x0,9m (1m x 3seg)	3	174	58	10,5W	15 sets	10	82,00€
163675	LED	Light Icon <td>Eye Icon <td>4x1,5m (1m x 4seg)</td> <td>4</td> <td>304</td> <td>76</td> <td>25W</td> <td>10 sets</td> <td>6</td> <td>110,00€</td> </td>	Eye Icon <td>4x1,5m (1m x 4seg)</td> <td>4</td> <td>304</td> <td>76</td> <td>25W</td> <td>10 sets</td> <td>6</td> <td>110,00€</td>	4x1,5m (1m x 4seg)	4	304	76	25W	10 sets	6	110,00€
163682	LED	Light Icon <td>Eye Icon <td>4x1,5m (1m x 4seg)</td> <td>4</td> <td>304</td> <td>76</td> <td>25W</td> <td>10 sets</td> <td>6</td> <td>116,00€</td> </td>	Eye Icon <td>4x1,5m (1m x 4seg)</td> <td>4</td> <td>304</td> <td>76</td> <td>25W</td> <td>10 sets</td> <td>6</td> <td>116,00€</td>	4x1,5m (1m x 4seg)	4	304	76	25W	10 sets	6	116,00€
163699	LED	Light Icon <td>Eye Icon <td>4x1,5m (1m x 4seg)</td> <td>4</td> <td>304</td> <td>76</td> <td>25W</td> <td>10 sets</td> <td>6</td> <td>116,00€</td> </td>	Eye Icon <td>4x1,5m (1m x 4seg)</td> <td>4</td> <td>304</td> <td>76</td> <td>25W</td> <td>10 sets</td> <td>6</td> <td>116,00€</td>	4x1,5m (1m x 4seg)	4	304	76	25W	10 sets	6	116,00€
163705	LED	Light Icon <td>Eye Icon <td>4x1,5m (1m x 4seg)</td> <td>4</td> <td>304</td> <td>76</td> <td>25W</td> <td>10 sets</td> <td>6</td> <td>105,00€</td> </td>	Eye Icon <td>4x1,5m (1m x 4seg)</td> <td>4</td> <td>304</td> <td>76</td> <td>25W</td> <td>10 sets</td> <td>6</td> <td>105,00€</td>	4x1,5m (1m x 4seg)	4	304	76	25W	10 sets	6	105,00€

- ⚡ 230V dc □ CII
- 👁️ 1 CANAL ° IP65
- ⚡ NO INC. SMART LINK

CABLE ALIMENTACIÓN SMART LINK

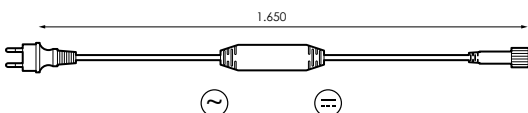



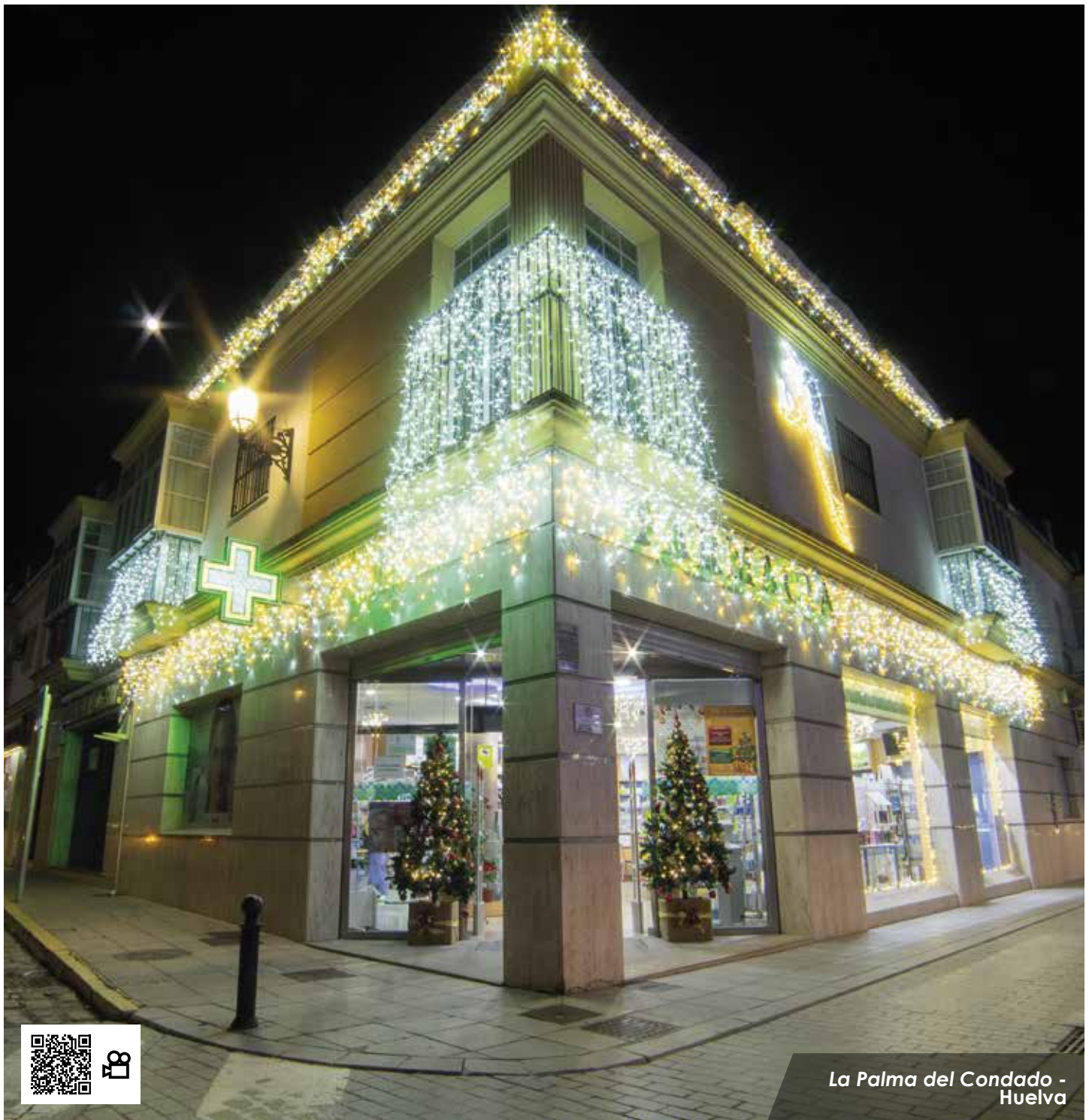





























Barcode	Light Icon	Voltage	Power	Plug Icon	Plug Icon	Box Icon	P.V.P.
995092	Light Icon	230Vac	Max. 480W	Plug Icon	IP44 Plug IP65 Conector	10	9,50€
977722	Light Icon	230Vac	Max. 480W	Plug Icon	IP44 Plug IP65 Conector	10	9,50€







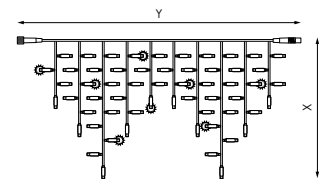

La Palma del Condado - Huelva

ICICLE FLASHING



							W			P.V.P.	
146388				3x0,5m (1,5m x 2seg)	2	114	49+8 flashing	8,2W	20 sets	10	68,00€
146371				3x0,5m (1,5m x 2seg)	2	114	49+8 flashing	8,2W	20 sets	10	70,00€
543019				3x0,5m (1,5m x 2seg)	2	114	49+8 flashing	8,2W	20 sets	10	66,00€
146395				3x0,9m (1m x 3seg)	3	174	50+8 flashing	11W	15 sets	10	92,00€
146401				3x0,9m (1m x 3seg)	3	174	50+8 flashing	11W	15 sets	10	95,00€
543033				3x0,9m (1m x 3seg)	3	174	50+8 flashing	11W	15 sets	10	90,00€
546591				4x1,5m (1m x 4seg)	4	304	66+10 flashing	25W	10 sets	5	120,00€
546607				4x1,5m (1m x 4seg)	4	304	66+10 flashing	25W	10 sets	5	130,00€



-  230V dc
-  CII
-  1 CANAL
-  IP65
-  NO INC.
-  SMART LINK



Los Silos -
Santa Cruz de Tenerife

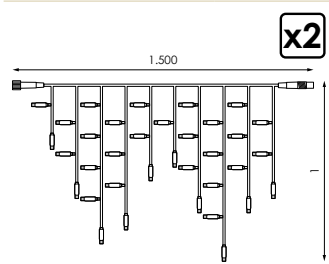

ICICLE

Serie Minimalist



Barcode	LED	Light Type	Length	Spacers	LEDs	Flashing	W	Sets	Boxes	P.V.P.
546973	LED	Standard	3x1m (1,5m x 2seg)	2	102	51	8W	15 sets	10	68,00€
546980	LED	Standard	3x1m (1,5m x 2seg)	2	102	51	8W	15 sets	10	71,00€

⚡ 230V dc	☐ CII
👁️ 1 CANAL	🌡️ IP65
🚫 NO INC.	SMART LINK

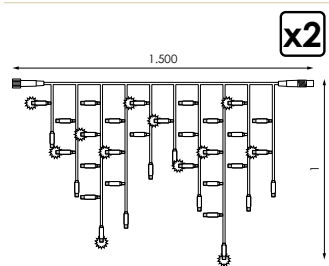

ICICLE FLASHING

Serie Minimalist



Barcode	LED	Light Type	Length	Spacers	LEDs	Flashing	W	Sets	Boxes	P.V.P.
546997	LED	Flashing	3x1m (1,5m x 2seg)	2	102	42+9 flashing	87W	15 sets	10	75,00€
547000	LED	Flashing	3x1m (1,5m x 2seg)	2	102	42+9 flashing	8W	15 sets	10	78,00€

⚡ 230V dc	☐ CII
👁️ 1 CANAL	🌡️ IP65
🚫 NO INC.	SMART LINK

CABLE ALIMENTACIÓN SMART LINK

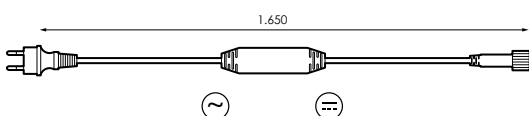

Barcode	Light Type	Voltage	Power	Connector	Boxes	P.V.P.
995092	Standard	230Vac	Max. 480W	IP44 Plug IP65 Conector	10	9,50€
977722	Flashing	230Vac	Max. 480W	IP44 Plug IP65 Conector	10	9,50€



ICICLE 174 RGB



							W			P.V.P.
546669			3x0,9m (1m x 3seg)	3	174	58	13,8W	11 sets	10	119,00€

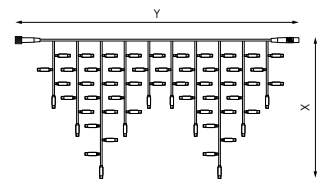

	230V dc		CII
	1 CANAL		IP65
	NO INC.		SMART LINK

CONTROLADOR RGB CON MANDO

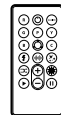
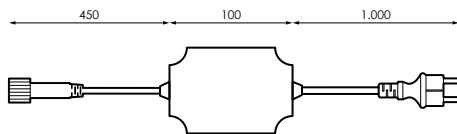

			W		P.V.P.
546683	230V	IP55	Max. 2.000leds	10	32,00€

Efecto memoria.
Memory effect.
Effet mémoire.
Efeito de memória.

CONTROLADOR POWER LINE RGB

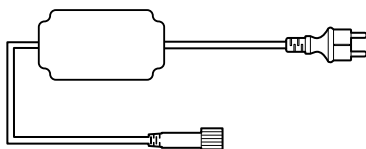

			W		P.V.P.
486262	230V	IP55	Max. 2.000leds	5	28,50€

Sincronización coordinada mediante una línea eléctrica. Cambio secuencial cada 15seg.
Coordinated synchronization through an electrical panel. Sequential change every 15sec.
Synchronisation coordonnée via un tableau électrique. Changement séquentiel toutes les 15s.
Sincronização coordenada através de um painel elétrico. Mudança sequencial a cada 15seg.



Viveiro - Lugo

Red

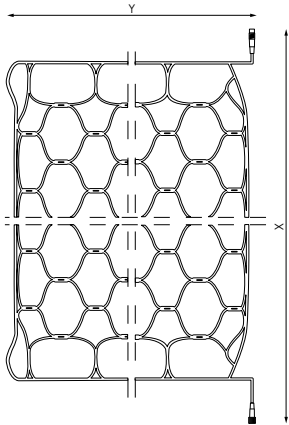

					W			P.V.P.
192231			2x1m	200	18W	15 sets	10	96,00€
192248			2x1m	200	18W	15 sets	10	99,00€
192255			2x1m	200	18W	15 sets	10	96,00€
192262			2x1m	200	18W	15 sets	10	99,00€
192279			4x2m	400	27W	7 sets	4	195,00€
192286			4x2m	400	27W	7 sets	4	199,00€
192293			4x2m	400	27W	7 sets	4	195,00€
192309			4x2m	400	27W	7 sets	4	199,00€
386081			2x1m	170+30 flashing	18W	15 sets	10	109,00€
386098			2x1m	170+30 flashing	18W	15 sets	10	114,00€
386104			4x2m	340+60 flashing	27W	7 sets	4	225,00€
386111			4x2m	340+60 flashing	27W	7 sets	4	230,00€

230V dc CII

1 CANAL IP65

NO INC. SMART LINK

CABLE ALIMENTACIÓN SMART LINK

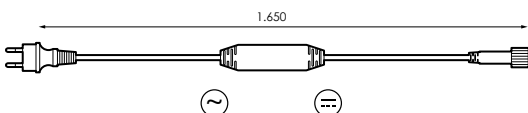

			W				P.V.P.
995092		230Vac	Max. 480W	CII	IP44 Plug IP65 Conector	10	9,50€
977722		230Vac	Max. 480W	CII	IP44 Plug IP65 Conector	10	9,50€



deco



Canarias

LED Fireworks



				W			P.V.P.
240789			Ø30cm	6,7W	80	10	42,90€
240796			Ø40cm	11W	120	10	53,90€
441759			Ø40cm	11W	120	10	53,90€
441780			Ø40cm	11W	120	10	58,85€
441810			Ø40cm	11W	120	10	58,85€
441735			Ø50cm	21,5W	240	10	86,90€
441766			Ø50cm	21,5W	240	10	86,90€
441797			Ø50cm	21,5W	240	10	94,60€
441827			Ø50cm	21,5W	240	10	94,60€
441742			Ø100cm	31,4W	480	10	141,90€
441773			Ø100cm	31,4W	480	10	141,90€
441803			Ø100cm	31,4W	480	10	153,45€
441834			Ø100cm	31,4W	480	10	153,45€

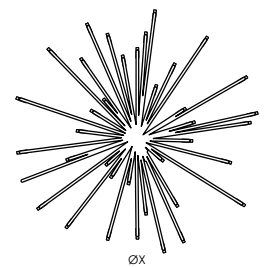

- 24V
- CIII
- IP44
- TR INC. 3m



Almonte -
Huelva



[GRÁFICOS: Unidades en mm/ GRAPHICS: Units in mm/ GRAPHIQUES: Unités en mm/ GRÁFICOS: Unidades em mm]

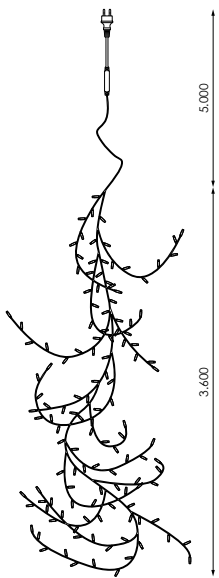

Branch LED



				W			P.V.P.
961998			3,6m	16W	288	6	165,00€
962001			3,6m	16W	288	6	169,00€
192866			3,6m	16W	288	6	169,00€
192873			3,6m	16W	288	6	169,00€

24V dc

CIII

IP44

TR INC.

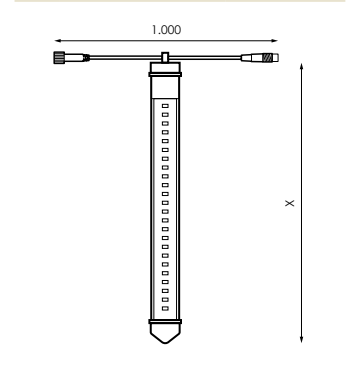

Fall Lite LED SMART



Barcode	LED	L	W	Light Bulb Icon	Light Bulb Icon	Box	P.V.P.
487498	LED	60cm	1,5W	144	100pc	60	29,50€
487504	LED	100cm	3W	192	100pc	25	39,00€

⚡ 230V ac 🌫️ IP44
 ✖️ NO INC. SMART LINK

CABLE ALIMENTACIÓN SMART LINK

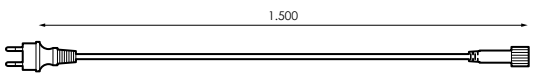

Barcode	Light Bulb Icon	Lightning Bolt	W	Box	Light Bulb Icon	Box	P.V.P.
193061	Light Bulb Icon	230Vac	Max. 480W	CII	IP44	10	5,60€
193078	Light Bulb Icon	230Vac	Max. 480W	CII	IP44	10	5,60€



Fall Lite LED



Barcode	LED	L	W	Light Bulb Icon	Box	P.V.P.
391450	LED	20cm	1W	E14	10	15,50€
543040	LED	20cm	1W	E14	10	15,50€
512916	LED	60cm	2W	E14	10	36,90€
543057	LED	60cm	2W	E14	10	36,90€
391474	LED	100cm	4W	E14	10	55,00€
543064	LED	100cm	4W	E14	10	55,00€

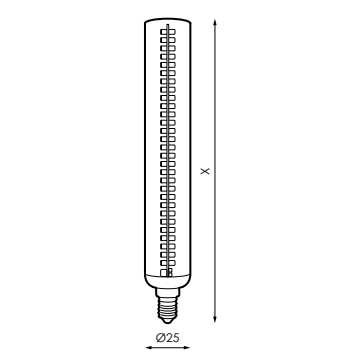

⚡ 230V 🌫️ IP44

SMART E14 SMART LINK

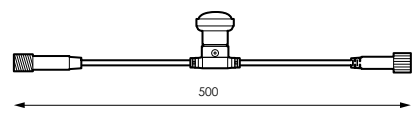

Barcode	Light Bulb Icon	Lightning Bolt	Box	P.V.P.
391528	Light Bulb Icon	E14	10	4,80€
391511	Light Bulb Icon	E14	10	4,80€

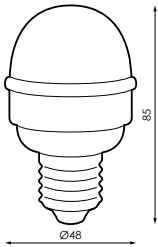

⚡ 230V IP44

esSENSE Ball LED basic



Barcode	LED Icon	W	Shield Icon	Dimensions Icon	Box Icon	P.V.P.
961240		1,5W	E27	Ø48x85mm	10/100	3,50€

Ñ/ Cambio de color sincronizado entre lámparas.
 E/ Change of color sync between lamps.
 F/ Changement de synchronisation de couleur entre les lampes.
 P/ Mudança de sincronização de cor entre lâmpadas.

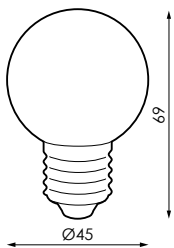

⚡ 230V ac IP44

esSENSE Ball LED



Barcode	LED Icon	W	Shield Icon	Dimensions Icon	Box Icon	P.V.P.
561228		1,6W	E27	Ø45x69mm	10/100	3,50€
561235		1,6W	E27	Ø45x69mm	10/100	3,50€
391276		1,5W	E27	Ø45x69mm	10/100	3,50€
391269		1,5W	E27	Ø45x69mm	10/100	3,50€
391290		1,5W	E27	Ø45x69mm	10/100	3,50€
391283		1,5W	E27	Ø45x69mm	10/100	3,50€



Pebetero LED



Barcode	LED	W	E14	Dimensions	Pack	P.V.P.
561174	LED	2W	E14	Ø21,8x51mm	100	2,20€
561181	LED	2W	E14	Ø21,8x51mm	100	2,20€
561198	LED	2W	E14	Ø21,8x51mm	100	2,10€
561204	LED	2W	E14	Ø21,8x51mm	100	2,10€
561211	LED	2W	E14	Ø21,8x51mm	100	2,10€
563710	LED	2W	E14	Ø21,8x51mm	100	2,10€

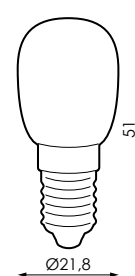

⚡ 230V ac ⚡ IP44



Guirnalda E14/E27



Barcode	Symbol	L (x)	L (l)	W/⊕	E14/E27	Pack	P.V.P.
392105	☑	15m	25cm	20W	60 (E14)	10	122,50€
392112	☑	50m	25cm	5W	200 (E14)	1	380,00€
392075	☑	15m	30cm	20W	45 (E27)	1	120,00€
446433	☑	25m	50cm	20W	50 (E27)	1	175,00€
446440	☑	50m	100cm	20W	50 (E27)	1	259,00€
392082	☑	50m	33cm	5W	150 (E27)	1	385,00€
392099	☑	100m	33cm	2W	300 (E27)	1	679,00€

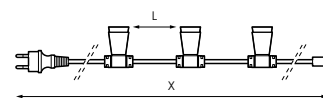

⚡ 230V ac ⚡ CI
 ☑ IP44 ⚡ INC.



Cuidad de Braga 2020
by AM Illumination
Producto Prilux



motivos

motif
motifs
motives



Felices Fiestas

Felices Fiestas

Felices Fiestas Corporeo



	W						P.V.P.
546201	9W			200x32cm	4kg	105x35x10cm	450,00€
546218	9W			200x32cm	4kg	105x35x10cm	450,00€
546225	15W			400x64cm	8kg	207x67x10cm	720,00€
546232	15W			400x64cm	8kg	207x67x10cm	720,00€

	230V		CII
	IP44		INC.



Feliz Navidad

Feliz Navidad

Feliz Navidad Corporeo



	W						P.V.P.
546140	9W			200x35,5cm	4kg	120x37x10cm	450,00€
546157	9W			200x35,5cm	4kg	120x37x10cm	450,00€
546164	15W			400x71cm	8kg	243x75x10cm	720,00€
546171	15W			400x71cm	8kg	243x75x10cm	720,00€

	230V		CII
	IP44		INC.



Felices Fiestas 6m



⚡ 230V	☑ CII
🌫 IP65 IP44 Plug	⚖ 38kg
📏 300x220x20cm	🔌 INC.

567169	flexi DOBLE NEON	STRING PLUS	368W	600x220cm	P.V.P. 1.575,00€
--------	------------------	-------------	------	-----------	------------------

Felices Fiestas Felices Fiestas

A

B



Felices Fiestas



⚡ 230V	☑ CII
🌫 IP65 IP44 Plug	🔌 INC.

Barcode	Label	flexi	W	Dimensions	Weight	Size	P.V.P.
385046	A	flexi	40W	206x36,5cm	4kg	209x40x5cm	368,00€
094863	B	flexi	40W	206x36,5cm	4kg	209x40x5cm	358,00€
385053	A	flexi	56W	310x55cm	8kg	313x58x5cm	510,00€
094788	B	flexi	56W	310x55cm	8kg	313x58x5cm	500,00€



A

B



Felices Fiestas con Estrella de Mar



⚡ 230V	☑ CII
🌫 IP65 IP44 Plug	🔌 INC.

Barcode	Label	flexi	FLASH BULB	W	Dimensions	Weight	Size	P.V.P.
149358	A	flexi	FLASH BULB	73W	267x82cm	8kg	270x83x5cm	720,00€
149372	B	flexi	FLASH BULB	73W	267x82cm	8kg	270x83x5cm	710,00€
149365	A	flexi	FLASH BULB	120W	530x170cm	26kg	275x173x7,5cm	1.250,00€
149389	B	flexi	FLASH BULB	120W	530x170cm	26kg	275x173x7,5cm	1.240,00€



Felices Fiestas con Estrellas y Bolas



Barcode	Symbol	Model	W	Dimensions	Weight	Size	P.V.P.
149396	flexi LED	CHRISTMAS BALL	57W	267x82cm	8kg	270x84x5cm	710,00€
149402	flexi LED	CHRISTMAS BALL	116W	530x170cm	23kg	275x150x7,5cm	1.250,00€

⚡	230V	☐	CII
🔌	IP65 IP44 Plug	🔌	INC.



Felices Fiestas con Cometa



Barcode	Symbol	Model	W	Dimensions	Weight	Size	P.V.P.
149426	flexi LED LED		78W	267x82cm	8kg	270x84x5cm	730,00€
149419	flexi LED LED		156W	530x170cm	26kg	275x173x7,5cm	1.250,00€

⚡	230V	☐	CII
🔌	IP65 IP44 Plug	🔌	INC.



A

B

Felices Fiestas rama



Barcode	Symbol	Model	W	Dimensions	Weight	Size	P.V.P.
149488	A flexi LED LED		66W	255x60cm	4kg	258x63x5cm	615,00€
149471	B flexi LED LED		66W	255x60cm	4kg	258x63x5cm	610,00€
149501	A flexi LED LED		120W	420x98cm	18kg	220x100x7,5cm	1.060,00€
149495	B flexi LED LED		120W	420x98cm	18kg	220x100x7,5cm	1.050,00€

⚡	230V	☐	CII
🔌	IP65 IP44 Plug	🔌	INC.



Feliz Navidad

Feliz Navidad 6m



⚡ 230V	☑ CII
🌧 IP65 IP44 Plug	⚖ 35kg
📏 300x200x20cm	🔌 INC.

📏	1	2	■	W	↕	P.V.P.
567152	flexi DOBLE NEON	flexi	STRING PLUS	579W	600x200cm	1.980,00€



Feliz Navidad Abetos



⚡ 230V	☑ CII
🌧 IP65 IP44 Plug	⚖ 16kg
(2x) 97x77x5cm (2x) 30x32x5cm (1x) 51x53x5cm (1x) 99x33x5cm (1x) 305x557x5cm	🔌 INC.

📏	□	■	W	↕	P.V.P.	
509848	A	flexi	TAPIZ	132W	428x141cm	1.175,00€
509855	B	flexi	TAPIZ	132W	428x141cm	1.155,00€



Feliz Navidad



⚡ 230V	☑ CII
🌧 IP65 IP44 Plug	⚖ 17kg
📏 300x74x7,5cm	🔌 INC.

📏	□	W	↕	P.V.P.	
545372	A	flexi	78W	457x70cm	899,00€
545389	B	flexi	78W	457x70cm	889,00€



Bones Festes

Bones Festes con Cometa



Barcode	Shape	W	Dimensions	Weight	Dimensions	P.V.P.
385695	flexi	78W	267x82cm	8kg	270x84x5cm	730,00€
385701	flexi	156W	552x170cm	26kg	264x173x7,5cm	1.250,00€

230V	CII
IP65 IP44 Plug	INC.



Bones festes

A

B

Bones Festes rama



Barcode	Shape	W	Dimensions	Weight	Dimensions	P.V.P.
385657	A flexi	62W	257x60cm	7kg	260x63x5cm	615,00€
385664	B flexi	62W	257x60cm	7kg	260x63x5cm	610,00€
385671	A flexi	100W	420x98cm	18kg	220x100x7,5cm	1.060,00€
385688	B flexi	100W	420x98cm	18kg	220x100x7,5cm	1.050,00€

230V	CII
IP65 IP44 Plug	INC.



BOAS FESTAS

A

B

Boas Festas 6m



Barcode	Shape	W	Dimensions	P.V.P.
567183	A flexi DOBLE NEON	477W	600x130cm	1.575,00€
567176	B flexi DOBLE NEON	477W	600x130cm	1.575,00€

230V	CII
IP65 IP44 Plug	30kg
390x130x7,5cm	INC.



ZORIONAK ZORIONAK

A

B

ZORIONAK ZORIONAK

C

D

Zorionak



Barcode		□	W	↕	kg	⊠	P.V.P.
389556	A	flexi LED	47,5W	300x55cm	10kg	303x57x5cm	520,00€
193313	B	flexi LED	47,5W	300x55cm	10kg	303x57x5cm	510,00€
489119	C	flexi DOUBLE NEON LED	270W	300x55cm	18kg	303x57x5cm	570,00€
489126	D	flexi DOUBLE NEON LED	270W	300x55cm	18kg	303x57x5cm	570,00€
544276	A	flexi LED	90W	520x90cm	16kg	300x95x7,5cm	965,00€
544269	B	flexi LED	90W	520x90cm	16kg	300x95x7,5cm	950,00€

⚡ 230V □ CII

🔌 IP65 IP44 Plug 🗑️ INC.



Bonnes Fêtes

Bonnes Fêtes con Cometa



Barcode	1	2	W	↕	kg	⊠	P.V.P.
494885	flexi LED	flexi LED	81W	272,3x903cm	8,5kg	277x907x7,5cm	695,00€
526159	flexi LED	flexi LED	165W	500x167cm	26kg	264x173x7,5cm	1.349,00€

⚡ 230V □ CII

🔌 IP65 IP44 Plug 🗑️ INC.



Lateral

Central

Lateral

Ice Waves Pattern



				W				P.V.P.
560306	C	flexi LED LED	STRING PLUS LED	91W	141,8x169,5cm	6,5kg	147x173x7,5cm	712,00€
560290	L	flexi LED LED	STRING PLUS LED	87W	200x168,1cm	10,5kg	205x173x7,5cm	805,00€

⚡	230V	☐	CII
🌧️	IP65 IP44 Plug	♻️	INC.



Star Duo



				W		P.V.P.
529099		flexi LED LED	STRING PLUS LED	45,6W	149,3x259,2cm	430,00€

⚡	230V	☐	CII
🌧️	IP65 IP44 Plug	⚖️	6kg
📏	155x252x5cm	♻️	INC.



Silhouette Star



		1	2	W		P.V.P.
529020		flexi LED	flexi LED	51W	149,3x259,2cm	425,00€

⚡	230V	☐	CII
🌧️	IP65 IP44 Plug	⚖️	6kg
📏	154x264x5cm	♻️	INC.



Ávila



Infinity



⚡ 230V	☐ CII
⚡ IP65 IP44 Plug	⚖ 6kg
🌀 260x78x5cm	🔌 INC.

Barcode	Code	flexi	LED	LED	W	↕	P.V.P.
416092	A	flexi	LED	LED	45W	252x76cm	440,00€
416108	B	flexi	LED	LED	45W	252x76cm	436,00€
416115	C	flexi	LED	LED	45W	252x76cm	430,00€
416122	D	flexi	LED	LED	45W	252x76cm	430,00€
416139	E	flexi	LED	LED	45W	252x76cm	436,00€

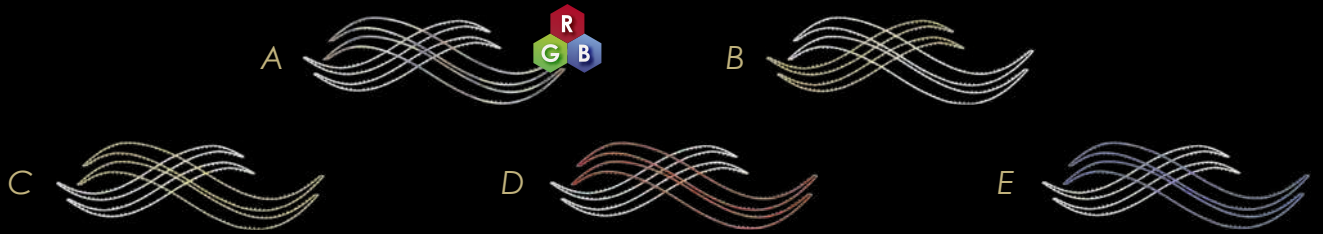

Wimbi



			W		P.V.P.
488730	A	flexi	40W	203x70cm	495,00€
412902	B	flexi	40W	203x70cm	395,00€
415408	C	flexi	40W	203x70cm	395,00€
415415	D	flexi	40W	203x70cm	389,00€
415422	E	flexi	40W	203x70cm	392,00€

	230V		CII
	IP65 IP44 Plug		4kg
	205x73x5cm		INC.



Angel Vela



			1	2	W		P.V.P.
210003	A	flexi	STRING	TAPIZ	62,5W	129,4x239,4cm	579,00€
387408	B	flexi	STRING	TAPIZ	62,5W	129,4x239,4cm	570,00€

	230V		CII
	IP65 IP44 Plug		7,5kg
	150x263x5cm		INC.



Agard



			W		P.V.P.	
209823	A	flexi	STRING	45W	303,5x72,5cm	434,00€
209847	B	flexi	STRING	45W	303,5x72,5cm	434,00€
209878	C	flexi	STRING	45W	303,5x72,5cm	430,00€

	230V		CII
	IP65 IP44 Plug		8kg
	312x80x5cm		INC.

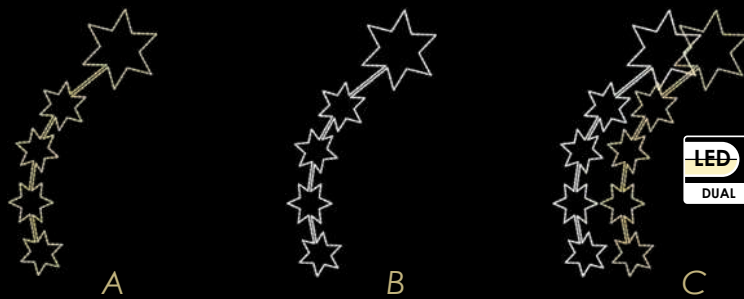

Estrellas



⚡ 230V	☐ CII
⊙ IP65 IP44 Plug	⚖ 8kg
🌀 210x121x5cm	🔌 INC.

Barcode	Code	Model	LED	W	Size	P.V.P.
385244	A	flexi	LED	21W	207,5x119cm	325,00€
972062	B	flexi	LED	21W	207,5x119cm	320,00€
385251	C	flexi	LED	25W	207,5x119cm	385,00€



Bulán



⚡ 230V	☐ CII
⊙ IP65 IP44 Plug	⚖ 6kg
🌀 115x115x5cm	🔌 INC.

Barcode	Code	Model	LED	STRING PLUS	LED	W	Size	P.V.P.
414982	A	flexi	LED	STRING PLUS	LED	36W	113x113cm	415,00€
567343	B	flexi	LED	STRING PLUS	LED	36W	113x113cm	415,00€
567350	C	flexi	LED	STRING PLUS	LED	36W	113x113cm	420,00€

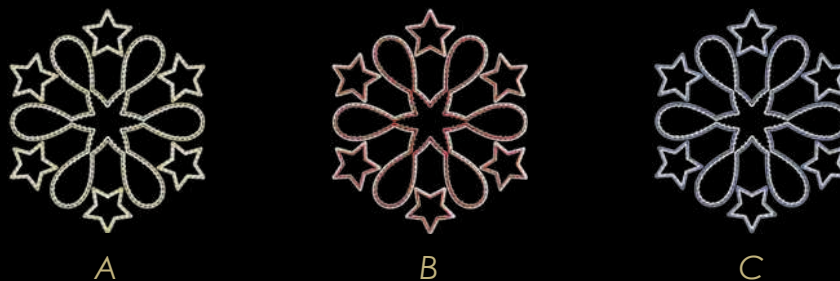

Stea



⚡ 230V	☐ CII
⊙ IP65 IP44 Plug	⚖ 8kg
🌀 135x160x5cm	🔌 INC.

Barcode	Code	Model	LED	W	Size	P.V.P.
441629	A	flexi	LED	78W	145,3x130cm	469,00€
441636	B	flexi	LED	78W	145,3x130cm	450,00€
441643	C	flexi	LED	78W	145,3x130cm	460,00€



A

B

Melchor, Gaspar



Barcode	Model	flexi	LED	LED	LED	STRING PLUS	LED	W	Dimensions	Weight	P.V.P.
567190	A	flexi	LED	LED	LED	STRING PLUS	LED	119W	220x100cm	8kg	678,00€
567206	B	flexi	LED	LED	LED	STRING PLUS	LED	135W	220x100cm	8kg	678,00€

⚡	230V	☐	CII
🔌	IP65 IP44 Plug	♻️	INC.
📏	110x225x5cm		



A

B

Baltasar, Camello



Barcode	Model	flexi	LED	LED	LED	LED	STRING PLUS	LED	W	Dimensions	Weight	P.V.P.
567213	A	flexi	LED	LED	LED	LED	STRING PLUS	LED	125W	220x100cm	8kg	678,00€
567220	B	flexi	LED	LED			-		39W	220x100cm	5kg	360,00€

⚡	230V	☐	CII
🔌	IP65 IP44 Plug	♻️	INC.
📏	110x225x5cm		



Reyes Magos con Estrella Fugaz



Barcode	flexi	LED	LED	W	Dimensions	P.V.P.
567367	flexi	LED	LED	270W	480x220cm	1.780,00€

⚡	230V	☐	CII
🔌	IP65 IP44 Plug	♻️	32kg
📏	170x230x20cm		
		♻️	INC.



Belén 2D



⚡ 230V	📦 CII
🌧️ IP65 IP44 Plug	⚖️ 15kg
📏 280x200x7,5cm	🔌 INC.



563635



flexi LED LED

W

175W



480x220cm

P.V.P.

890,00€





Lilium



Barcode	flexi LED	W	Ø	kg	Dimensions	P.V.P.
510141		36W	Ø78cm	4kg	83x83x5cm	309,00€
510165		54W	Ø117cm	6kg	122x122x5cm	375,00€

	230V		CII
	IP65 IP44 Plug		INC.



Reno DOUBLE NEON



Barcode	flexi DOUBLE NEON LED	W	Dimensions	Dimensions	P.V.P.
487511		117W	180x110cm	186x116x5cm	339,00€

	230V		CII
	IP65 IP44 Plug		INC.



Reno DOUBLE NEON



Barcode	flexi DOUBLE NEON LED	W	Dimensions	Dimensions	P.V.P.
487528		90W	140x93cm	146x90x5cm	269,00€

	230V		CII
	IP65 IP44 Plug		INC.



A



B



C

Star Flake



		W				P.V.P.	
194037	A	flexi	33W	Ø80cm	2,5kg	83x83x5cm	264,00€
194013	B	flexi	33W	Ø80cm	2,5kg	83x83x5cm	257,00€
194044	C	flexi	33W	Ø80cm	2,5kg	83x83x5cm	255,00€
194068	A	flexi	51W	Ø120cm	4,5kg	123x123x5cm	370,00€
194051	B	flexi	51W	Ø120cm	4,5kg	123x123x5cm	359,00€
194075	C	flexi	51W	Ø120cm	4,5kg	123x123x5cm	356,00€

⚡ 230V

IP65 IP44 Plug



A



B



C



Cometa II



		W				P.V.P.	
489560	A	flexi DOUBLE NEON	63W	107x47cm	2kg	110x50x5cm	259,00€
488815	B	flexi DOUBLE NEON	63W	107x47cm	2kg	110x50x5cm	259,00€
488785	C	flexi	32,2W	107x47cm	2kg	110x50x5cm	299,00€
489577	A	flexi DOUBLE NEON	90W	158x68cm	3,5kg	159x71x5cm	355,00€
488822	B	flexi DOUBLE NEON	90W	158x68cm	3,5kg	159x71x5cm	355,00€
488792	C	flexi	46W	158x68cm	3,5kg	159x71x5cm	399,00€
489584	A	flexi DOUBLE NEON	189W	308x130cm	9kg	311x133x5cm	595,00€
488839	B	flexi DOUBLE NEON	189W	308x130cm	9kg	311x133x5cm	595,00€
488808	C	flexi	96,6W	308x130cm	9kg	311x133x5cm	699,00€

⚡ 230V

IP65 IP44 Plug



Golden Star PMMA



			W		P.V.P.
566445	flexi	PMMA	13W	70x67cm	145,00€

	230V		CII
	IP44		5kg
	75x72x5cm		INC.



Red Loop



			W		P.V.P.
566452	flexi	STRING	9W	50x46cm	117,00€

	230V		CII
	IP44		2,3kg
	55x50x5cm		INC.



A



B



C

Tear



			W		P.V.P.
510455	A	flexi	9W	50x40cm	89,00€
510462	B	flexi	9W	50x40cm	89,50€
510479	C	flexi	14W	50x40cm	135,00€

	230V		CII
	IP65 IP44 Plug		1,7kg
	55x45x5cm		INC.



Plaza Luis López>Allue -
Huesca



A

B

Ring Ribbon



Barcode	Code	Model	W	Dimensions	Weight	Box Size	P.V.P.
487535	A	flexi DOUBLE NEON	9W	Ø32cm	1kg	35x35x5cm	48,40€
487542	B	flexi DOUBLE NEON	9W	Ø32cm	1kg	35x35x5cm	48,40€
487559	A	flexi DOUBLE NEON	18W	Ø64cm	2kg	67x67x5cm	64,70€
487566	B	flexi DOUBLE NEON	18W	Ø64cm	2kg	67x67x5cm	64,70€
487573	A	flexi DOUBLE NEON	27W	Ø95,5cm	3kg	99x99x5cm	85,50€
487580	B	flexi DOUBLE NEON	27W	Ø95,5cm	3kg	99x99x5cm	85,50€

BAJO PEDIDO

977722	Cable alimentación Blanco IP44	9,50€
--------	--------------------------------	-------

	230V		CII
	IP20		INC.



A

B

C

Star Mini DOUBLE



Barcode	Code	Model 1	Model 2	W	Dimensions	Weight	Box Size	P.V.P.
412742	A	flexi	flexi	5,9W	Ø30cm	1kg	35x35x5cm	89,00€
412766	B	flexi	flexi	5,9W	Ø30cm	1kg	35x35x5cm	88,00€
412773	C	flexi	flexi	5,9W	Ø30cm	1kg	35x35x5cm	88,50€
412803	A	flexi	flexi	11,2W	Ø60cm	1,5kg	65x65x5cm	110,20€
412827	B	flexi	flexi	11,2W	Ø60cm	1,5kg	65x65x5cm	108,50€
412834	C	flexi	flexi	11,2W	Ø60cm	1,5kg	65x65x5cm	109,80€

	230V		CII
	IP65 IP44 Plug		INC.



Double Star



⚡ 230V	☑ CII
🌫 IP44	⚖ 2kg
📏 44x54x3,5cm	🔌 INC.

Barcode		1	2	W	↔	⚖	📏	P.V.P.
412865	A	flexi LED	flexi LED	5,9W	70x55cm	1kg	75x60x5cm	137,00€
412872	B	flexi LED	flexi LED	5,9W	70x55cm	1kg	75x60x5cm	136,20€
412889	C	flexi LED	flexi LED	5,9W	70x55cm	1kg	75x60x5cm	136,60€



Star 8 Puntas PMMA



⚡ 230V	☑ CII
🌫 IP44	⚖ 2kg
📏 44x54x3,5cm	🔌 INC.

Barcode			W	↔	P.V.P.
442626	flexi LED	PMMA	12W	45x39cm	75,00€
442633	flexi LED	PMMA	12W	45x39cm	75,00€



Star 8 Puntas DOBLE



⚡ 230V	☑ CII
🌫 IP44	⚖ 2kg
📏 76x98x3,5cm	🔌 INC.

Barcode	1	2	W	↔	P.V.P.
442664	flexi LED	flexi LED	11W	88x70cm	159,00€



A



B



C

Mini Snow



Barcode	Code	flexi LED	W	↕	P.V.P.
194426	A	flexi LED	15W	Ø50cm	119,50€
194433	B	flexi LED	15W	Ø50cm	122,50€
194457	C	flexi LED	15W	Ø50cm	116,00€

⚡	230V	☐	CII
🔌	IP65 IP44 Plug	⚖️	2kg
📏	55x55x3cm	🔌	INC.



A



B



C

Star Flake Mini



Barcode	Code	flexi LED	W	↕	P.V.P.
195164	A	flexi LED	15W	Ø50cm	116,00€
195171	B	flexi LED	15W	Ø50cm	119,50€
195188	C	flexi LED	15W	Ø50cm	122,50€

⚡	230V	☐	CII
🔌	IP65 IP44 Plug	⚖️	2kg
📏	55x55x3cm	🔌	INC.



Colección Straight

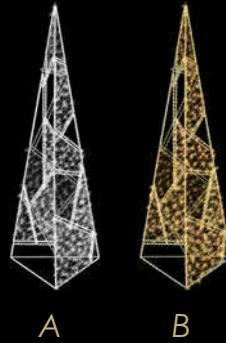

Straight Cone 3D



⚡ 24V	⬠ CIII
🌡 IP65 IP44 Plug	⚖ 14,5kg
📏 255x70x70cm	🔌 INC.

Barcode	Code	Material	1	2	W	Dimensions	P.V.P.
194426	A	flexi LED	STRING PLUS LED	PVC NET	60W	250x65x65cm	945,00€
194433	B	flexi LED	STRING PLUS LED	PVC NET	60W	250x65x65cm	965,00€



Selfie Alas Ángel



⚡ 24V	⬠ CIII
🌡 IP65 IP44 Plug	⚖ 42kg
🔌 INC.	

Barcode	Code	Material	1	2	3	W	Dimensions	P.V.P.
562089		flexi LED	STRING PLUS LED	TAPIZ	STRING PLUS LED	135W	412x301cm	2.870,00€



Selfie Penguin



Reno 3D STANDING



		1	2	W		P.V.P.
563086	flexi LED	STRING PLUS LED	TAPIZ	95W	254x163x20cm	1.160,00€

	24V		CIII
	IP65 IP44 Plug		35kg
	INC.		



Reno 3D SIT



		1	2	W		P.V.P.
563093	flexi LED	STRING PLUS LED	TAPIZ	90W	210x180x20cm	1.130,00€

	24V		CIII
	IP65 IP44 Plug		30kg
	INC.		



Reno 3D PASTANDO



		1	2	W		P.V.P.
563109	flexi LED	STRING PLUS LED	TAPIZ	95W	150x210x20cm	1.160,00€

	24V		CIII
	IP65 IP44 Plug		34kg
	INC.		



Basic Gift BOX



⚡ 24V		◆ CIII	📊	□	■	W	↔	P.V.P.
🌧️ IP65 IP44 Plug	📦 130kg	565127	flexi LED	STRING PLUS	LED	240W	3,4x3,4x3,4m	7.105,00€
🔌 INC.		565141	flexi LED	STRING PLUS	LED	240W	3,4x3,4x3,4m	7.028,00€



Túnel



⚡ 12V		◆ CIII	📊	□	W	↔	P.V.P.
🌧️ IP65 IP44 Plug	📦 350kg	511247	STRING PIXELMAX	LED	4.980W	3,14x2,80x10,24m	26.900,00€

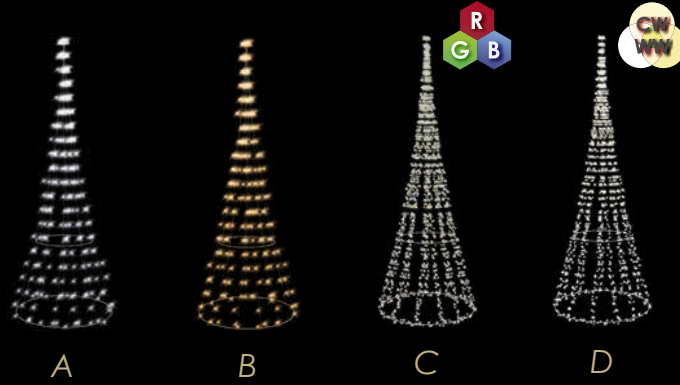

Cone String



Barcode	Code	String	LED	W	Dimensions	Weight	Dimensions	P.V.P.
444804	A	STRING PLUS	LED	18W	Ø50x150cm	5kg	155x52x52cm	349,00€
444811	B	STRING PLUS	LED	18W	Ø50x150cm	5kg	155x52x52cm	353,00€
488891	C	STRING PLUS	LED	28W	Ø50x150cm	5kg	155x52x52cm	395,00€
510547	D	STRING PLUS	LED	28W	Ø50x150cm	5kg	155x52x52cm	395,00€
416085	A	STRING PLUS	LED	36W	Ø100x250cm	9kg	255x105x105cm	855,00€
444903	B	STRING PLUS	LED	36W	Ø100x250cm	9kg	255x105x105cm	867,00€
488921	C	STRING PLUS	LED	46W	Ø100x250cm	9kg	255x105x105cm	975,00€
510561	D	STRING PLUS	LED	46W	Ø100x250cm	9kg	255x105x105cm	975,00€

⚡ 24V	⬠ CIII
🔌 IP65 IP44 Plug	🔌 INC.

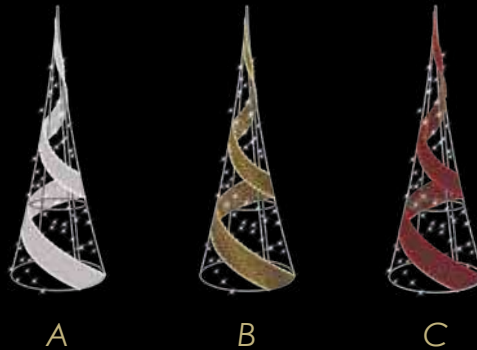

Cone Loop



Barcode	Code	String	LED	TAPIZ	W	Dimensions	Weight	Dimensions	P.V.P.	
444651	A	flexi LED	STRING PLUS	LED	TAPIZ	21W	Ø50x150cm	5kg	155x52x52cm	419,00€
444668	B	flexi LED	STRING PLUS	LED	TAPIZ	21W	Ø50x150cm	5kg	155x52x52cm	419,00€
444675	C	flexi LED	STRING PLUS	LED	TAPIZ	21W	Ø50x150cm	5kg	155x52x52cm	415,00€
444750	A	flexi LED	STRING PLUS	LED	TAPIZ	48W	Ø100x250cm	15kg	255x105x105cm	895,00€
444767	B	flexi LED	STRING PLUS	LED	TAPIZ	48W	Ø100x250cm	15kg	255x105x105cm	899,00€
444774	C	flexi LED	STRING PLUS	LED	TAPIZ	48W	Ø100x250cm	15kg	255x105x105cm	880,00€
545655	A	flexi LED	STRING PLUS	LED	TAPIZ	140W	Ø200x450cm	35kg	255x52x52cm 205x205x205cm	2.985,00€
545662	B	flexi LED	STRING PLUS	LED	TAPIZ	140W	Ø200x450cm	35kg	255x52x52cm 205x205x205cm	2.995,00€
545679	C	flexi LED	STRING PLUS	LED	TAPIZ	140W	Ø200x450cm	35kg	255x52x52cm 205x205x205cm	2.929,00€

⚡ 24V	⬠ CIII
🔌 IP65 IP44 Plug	🔌 INC.



Cone Loop PVC NET



⚡ 24V	⬠ CIII
🌫 IP44	⚠ 15kg
📏 255x105x105cm	🔌 INC.

📏	1	2	■	🔌	W	↔	P.V.P.				
512237	flexi	LED	STRING	PLUS	LED	PVC NET	CHRISTMAS BALL	🌟	56W	Ø100x250cm	1.090,00€



A



B

Maple Tree













⚡ 24V	⬠ CIII
🌫 IP44	📦 1 ud.
🔌 INC.	

📏		💡	W	🌟	↔	P.V.P.
506311	A	LED	100W	1376	2,8m	2.108,40€
506328	B	LED	100W	1376	2,8m	2.118,00€
506335	A	LED	180W	2924	5m	4.176,00€
506342	B	LED	180W	2924	5m	4.204,32€
506359	A	LED	250W	4000	8m	7.235,00€
506397	B	LED	250W	4000	8m	7.265,00€



Autumn Tree



		W			P.V.P.	 24V	 CIII
506434		100W	1664	3,5m	4.415,80€	 IP44	 1 ud.
506441		100W	1664	3,5m	3.938,00€	 INC.	



CC. Lagoh - Sevilla



A



B



C



D



Cherry Blossom Tree



Barcode	Model	LED Icon	W	Light Icon	Dimensions	P.V.P.
210461	A	LED	60W	800	1,8x1,3m	1.471,80€
210478	B	LED	60W	800	1,8x1,3m	1.501,50€
210485	C	LED	60W	800	1,8x1,3m	1.556,50€
506281	D	RGB LED	60W	800	1,8x1,3m	1.649,00€
210492	A	LED	150W	2120	2,8x2,2m	3.588,90€
210508	B	LED	150W	2120	2,8x2,2m	3.639,70€
210515	C	LED	150W	2120	2,8x2,2m	3.680,00€
506298	D	RGB LED	150W	2120	2,8x2,2m	3.548,50€
408226	A	LED	300W	4100	3,6x3m	6.235,00€
408233	B	LED	300W	4100	3,6x3m	6.260,00€
408240	C	LED	300W	4100	3,6x3m	6.925,00€
408257	A	LED	350W	5200	4,5x3,5m	8.752,00€
408264	B	LED	350W	5200	4,5x3,5m	8.869,00€
408271	C	LED	350W	5200	4,5x3,5m	9.269,00€

⚡ 24V	◇ CIII
🌧 IP44	📦 1 ud.
🔌 INC.	



Oviedo

Giant Cone RGB PIXELMAX NO TRANSITABLE



				W		P.V.P.	12V	CIII
567374	4,965m	STRING PIXELMAX	RGB	1.030W	135kg	7.990,00€	IP65 IP44 Plug	1 ud.
							INC.	

Información/Information/Information/Informações



N/ Todos los materiales se sirven ya montados, en el Giant Cone PIXELMAX.

E/ All materials are served already assembled, in the Giant Cone PIXELMAX.

F/ Tous les matériaux sont servis déjà assemblés, dans le Giant Cone PIXELMAX.

P/ Todos os materiais são servidos já montados, no Cone Gigante PIXELMAX.



Gijón



Giant Cone RGB PIXELMAX TRANSITABLE



⚡ 12V	⬠ CIII
🌧 IP65 IP44 Plug	📦 1 ud.
🔌 INC.	

📊	↕	🔗	💡	W	📦	P.V.P.
567381	6,945m	STRING PIXELMAX	RGB	1.316W	185kg	11.960,00€
567398	8,93m	STRING PIXELMAX	RGB	2.240W	275kg	17.990,00€
567404	10,92m	STRING PIXELMAX	RGB	3.780W	415kg	25.980,00€
567411	12,91m	STRING PIXELMAX	RGB	5.470W	580kg	33.900,00€
567428	20,9m	STRING PIXELMAX	RGB	12.500W	1.436kg	153.500,00€

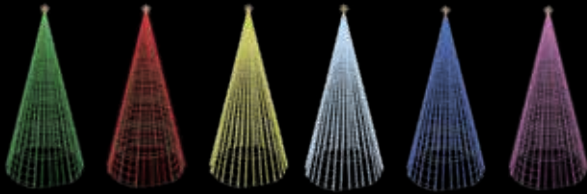

EJEMPLOS DE OPCIONES POSIBLES/ EXAMPLES OF POSSIBLE OPTIONS/
EXEMPLOS D'OPCIONES POSSIBLES/ EXEMPLOS DE POSSÍVEIS OPÇÕES

Giant Cone RGB



					W		P.V.P.
489799	6,34m	7,12m	STRING PLUS	RGB	250W	141kg	5.853,89€
489805	8,33m	9,11m	STRING PLUS	RGB	405W	200kg	9.320,56€
489812	10,32m	11,49m	STRING PLUS	RGB	625W	315kg	12.988,89€
489829	12,31m	13,48m	STRING PLUS	RGB	780W	460kg	17.500,00€

	230V		CII
	IP65 IP44 Plug		1 ud.
	INC.		



Giant Cone SPIRAL TAPIZ ROJO sin recubrimiento



				W		P.V.P.
511681	8,33m	9,11m	STRING PLUS CW + TAPIZ ROJO	439W	260kg	9.381,60€
511698	10,32m	11,49m	STRING PLUS CW + TAPIZ ROJO	659W	405kg	13.135,20€
511704	12,31m	13,48m	STRING PLUS CW + TAPIZ ROJO	813W	610kg	17.750,00€

	230V		CII
	IP65 IP44 Plug		1 ud.
	INC.		

Información/Information/Information/Informações



N/ Todos los materiales de los GIANT CONE se sirven por separado, excepto en el STRING PLUS CW y el STRING PLUS CW ESTRELLAS, que se sirve montado el string plus.

E/ All the materials of the GIANT CONE are served separately, except for the STRING PLUS CW and the STRING PLUS CW ESTRELLAS, which is served assembled with the string plus.

F/ Tous les matériaux du GIANT CONE sont servis séparément, à l'exception du STRING PLUS CW et du STRING PLUS CW ESTRELLAS, qui est servi assemblé avec le string plus.

P/ Todos os materiais do CONE GIGANTE são servidos separadamente, exceto o STRING PLUS CW e o STRING PLUS CW ESTRELLAS, que é servido montado com o string plus.

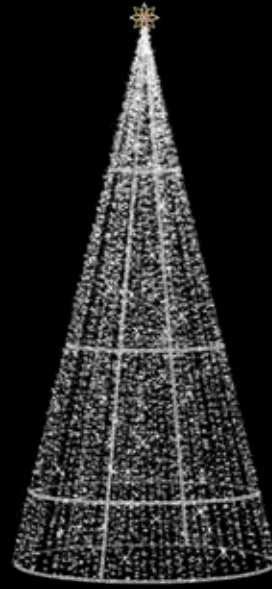

Giant Cone STRING CW sin recubrimiento



				W		P.V.P.
489904	6,34m	7,12m	STRING PLUS CW	293W	120kg	5.375,00€
489911	8,33m	9,11m	STRING PLUS CW	535W	190kg	9.189,00€
469067	10,32m	11,49m	STRING PLUS CW	815W	310kg	13.950,00€
489928	12,31m	13,48m	STRING PLUS CW	1.130W	475kg	18.795,00€

	230V		CII
	IP65 IP44 Plug		1 ud.
	INC.		



Giant Cone STRING ESTRELLAS sin recubrimiento



				W		P.V.P.
489942	8,33m	9,11m	STRING PLUS CW + 21 ESTRELLAS	1.085W	260kg	15.000,00€
489959	10,32m	11,49m	STRING PLUS CW + 29 ESTRELLAS	1.565W	402kg	20.882,22€
467520	12,31m	13,48m	STRING PLUS CW + 37 ESTRELLAS	2.005W	591kg	28.845,00€

	230V		CII
	IP65 IP44 Plug		1 ud.
	INC.		



Giant Ball PIXELMAX



Barcode	Dimensions	Material	Light Type	W	Weight	P.V.P.
567503	2,8x2,6m	flexi	STRING PIXELMAX LED	1.570W	127kg	14.650,00€
567497	4,3x4m	flexi	STRING PIXELMAX LED	2.700W	196kg	19.800,00€

⚡	12V/24V	⬠	CIII
🔌	IP65 IP44 Plug	📦	1 ud.
🔌	INC.		



Giant Ball STARS



Barcode	Dimensions	Material	Light Type	W	Weight	P.V.P.
567527	2,8x2,6m	flexi	STRING PLUS LED	210W	105kg	9.300,00€
567541	2,8x2,6m	flexi	STRING PLUS LED	210W	105kg	9.390,00€
567510	4,3x4m	flexi	STRING PLUS LED	375W	178kg	11.680,00€
567534	4,3x4m	flexi	STRING PLUS LED	375W	178kg	11.800,00€

⚡	24V	⬠	CIII
🔌	IP65 IP44 Plug	📦	1 ud.
🔌	INC.		



Galdar, Las Palmas - Gran Canarias

Sphere 3D



⚡ 230V	☐ CII
🌧️ IP65 IP44 Plug	📦 1 ud.
🔌 INC.	



Información
Information
Information
Informações

Ñ/ Motivo 3D PLEGABLE

E/ 3D FOLDING motive

F/Motif 3D PLIABLE

P/ Motivo 3D DOBRÁVEL

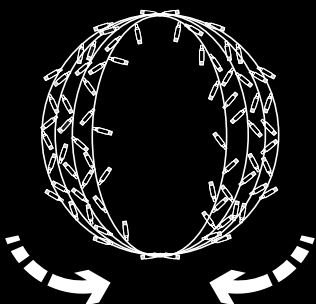

📊	💡	W	↕	📏	📦	P.V.P.
510585	STRING PLUS LED	9,2W	Ø50cm	2kg	53x53x53cm	250,00€
488853	STRING PLUS LED	9,2W	Ø50cm	2kg	53x53x53cm	250,00€
445764	STRING PLUS LED	8W	Ø50cm	2kg	53x53x53cm	196,00€
445771	STRING PLUS LED	8W	Ø50cm	2kg	53x53x53cm	199,00€
445788	STRING PLUS LED	8W	Ø50cm	2kg	53x53x53cm	210,00€
445795	STRING PLUS LED	8W	Ø50cm	2kg	53x53x53cm	214,00€
510592	STRING PLUS LED	18,5W	Ø90cm	4kg	93x93x40cm	490,00€
488860	STRING PLUS LED	18,5W	Ø90cm	4kg	93x93x40cm	490,00€
445450	STRING PLUS LED	14W	Ø90cm	4kg	93x93x40cm	415,00€
445467	STRING PLUS LED	14W	Ø90cm	4kg	93x93x40cm	420,00€
445511	STRING PLUS LED	14W	Ø90cm	4kg	93x93x40cm	434,00€
445528	STRING PLUS LED	14W	Ø90cm	4kg	93x93x40cm	439,00€
510608	STRING PLUS LED	37W	Ø130cm	6kg	133x133x50cm	780,00€
488877	STRING PLUS LED	37W	Ø130cm	6kg	133x133x50cm	780,00€
445474	STRING PLUS LED	27W	Ø130cm	6kg	133x133x50cm	685,00€
445481	STRING PLUS LED	27W	Ø130cm	6kg	133x133x50cm	690,00€
445535	STRING PLUS LED	27W	Ø130cm	6kg	133x133x50cm	725,00€
445542	STRING PLUS LED	27W	Ø130cm	6kg	133x133x50cm	730,00€
510615	STRING PLUS LED	46W	Ø160cm	7,5kg	163x163x60cm	985,00€
488884	STRING PLUS LED	46W	Ø160cm	7,5kg	163x163x60cm	985,00€
445498	STRING PLUS LED	34W	Ø160cm	7,5kg	163x163x60cm	890,00€
445504	STRING PLUS LED	34W	Ø160cm	7,5kg	163x163x60cm	900,00€
445559	STRING PLUS LED	34W	Ø160cm	7,5kg	163x163x60cm	940,00€
445566	STRING PLUS LED	34W	Ø160cm	7,5kg	163x163x60cm	950,00€

90cm



120cm



180cm



Reno 3D



		W			P.V.P.		
563253		3,6W	120	90cm	129,00€	31V	CIII
563246		3,6W	240	120cm	199,00€	IP44	1 ud.
563284		3,6W	360	180cm	345,00€	INC.	



Portal Xmas



Nacimiento 3D



⚡ 24V	⬠ CIII
🌫 IP44	👤 62kg
📦 1 ud.	🔌 INC.

📊	☐	1	2	W	↕	P.V.P.
511339	flexi LED LED	STRING PLUS LED LED	TAPIZ	259W	374,5x354cm	4.495,00€



Nacimiento 3D



⚡ 24V	⬠ CIII
🌫 IP44	👤 79kg
📦 1 ud.	🔌 INC.

📊	☐	1	2	W	↕	P.V.P.
511353	flexi LED LED	STRING PLUS LED LED	TAPIZ	402W	775,5x354cm	5.890,00€

Ñ/ Condiciones generales

La aceptación por nuestra parte de un pedido supone, en cualquier caso, que el comprador acepta las siguientes condiciones generales de venta y suministro:

1. Precios.

Los precios indicados son precios recomendados y se entienden sin I.V.A. ni Ecoraee y son válidos desde el 1 de Agosto de 2021 hasta nuevo aviso. Una vez realizada la factura se aplicarán ambos. Los precios de la Tarifa Vigente, son para aquellos materiales que se hallen en nuestros almacenes.

Nos reservamos el derecho de modificaciones de precios y características de los productos comunicándolo lo antes posible.

2. Plazos de entrega.

Nuestro plazo de entrega será inmediato y en su defecto, a corto plazo. Los plazos de entrega se respetarán según nuestras posibilidades, pero son sin compromiso. Dichos plazos son meramente informativos. Los retrasos en la entrega no autorizan al comprador a la anulación del pedido ni a la aplicación de penalizaciones ni indemnizaciones, salvo que se haya convenido expresamente lo contrario. Aun en este caso, habiendo causas de fuerza mayor de por medio, propia o ajena, deja de cumplirse alguno de los compromisos acordados, no será aplicable sanción alguna.

3. Ofertas.

Las ofertas escritas u orales, no nos comprometen a aceptarlas. Dichas ofertas tendrán validez una vez hayan sido ratificadas por escrito por GRUPO PRILUX ILUMINACION, S.L.U.

4. Transporte.

Una vez la mercancía haya sido entregada a la agencia de transportes, se considerará la entrega como correcta. Los riesgos de transporte en el envío de nuestros productos son por cuenta del comprador, que únicamente podrá reclamar a la agencia encargada del transporte los daños ocasionados en el mismo, en un plazo inferior a 7 días y por escrito con copia a Grupo Prilux Iluminación, S.L.U.

5. Reclamaciones.

Reclamaciones relativas a fallos numéricos y defectos, serán solo válidas si se ha enviado la oportuna reclamación dentro de los cinco primeros días a partir de la recepción de la mercancía.

6. Devoluciones de material.

No se aceptarán devoluciones de material si previamente GRUPO PRILUX ILUMINACION S.L.U. no lo ha autorizado. Estas devoluciones tendrán que remitirse a portes pagados con un demérito mínimo del 20%. No se acepta la devolución de productos de fabricación especial o de campañas (como la de navidad) y de productos que no vengan en sus embalajes originales y en buen estado. En cualquier caso no se aceptarán devoluciones de productos con antigüedad superior a 12 meses y será imprescindible facilitar el número de factura correspondiente.

7. Derechos de propiedad.

GRUPO PRILUX ILUMINACION, S.L.U. conserva, en todo caso, la plena propiedad de todos los materiales suministrados, en tanto no quede cumplida por entero la recíproca condición de pago del importe.

8. Pedidos.

Los pedidos en curso podrán ser anulados por Grupo Prilux Iluminación, S.L.U. si surgieran circunstancias de fuerza mayor que impidan que puedan suministrarse dichos pedidos. Los pedidos de materiales de fabricación especial no podrán anularse por el comprador sin nuestra aprobación por escrito. En caso de aceptación por nuestra parte, serán a cargo del comprador los gastos originados hasta el momento de su anulación.

9. Reproducción.

Queda prohibida la reproducción total o parcial de este catálogo sin la correspondiente autorización de GRUPO PRILUX ILUMINACION, S.L.U.

10. Forma de pago.

La forma de pago será la establecida en el momento de efectuar el pedido en firme de la mercancía, de acuerdo con las normas usuales de GRUPO PRILUX ILUMINACION, S.L.U.

11. Lugar de cumplimiento y jurisdicción.

Para cuantas cuestiones puedan surgir en el cumplimiento o interpretación de estas normas generales, los contratantes, con renuncia expresa de cualquier jurisdicción pudieran corresponderles, se someten expresamente a los Juzgados y Tribunales de Toledo.

12. Elementos defectuosos y garantía.

El período de garantía comienza en la fecha de factura de GRUPO PRILUX ILUMINACION, S.L.U. La responsabilidad se aplica a los materiales y defectos de fabricación según los estándares técnicos de cada producto. El producto debe instalarse de acuerdo a la normativa vigente y especificaciones de GRUPO PRILUX ILUMINACION, S.L.U. El período de garantía general es de 1 año a partir de la fecha de factura de la mercancía, a excepción de los productos que por sus características técnicas tienen una duración inferior a este período. El período de garantía tiene en cuenta los ciclos de encendidos y apagados marcados en la norma IEC. Finalizado este período, cualquier reclamación, incluso por daños, será rechazada/excluida.

Los productos de navidad, al ser de temporada, tienen montaje y desmontaje normalmente. Esta manipulación y su posterior mantenimiento, es responsabilidad del instalador. GRUPO PRILUX ILUMINACION, S.L.U. no se hace responsable del producto sino se ha producido el mismo.

En caso de defectos la responsabilidad del vendedor estará limitada al precio de venta de la parte defectuosa del producto. Especialmente no habrá responsabilidad de reembolso de los gastos incurridos por el comprador o cambio de productos. Se aplicará especialmente en algún desembalaje y reinstalación de los productos.

GRUPO PRILUX ILUMINACION, S.L.U. no se responsabiliza de los daños causados por el cliente o por una tercera persona externa al producto. GRUPO PRILUX ILUMINACION, S.L.U. no se responsabiliza de las alteraciones o cambios realizados en cualquiera de los productos por terceras personas.

Se limita la responsabilidad del vendedor en aquellos casos de negligencia grave o daños ocasionados intencionadamente.

La compañía no se responsabiliza de los productos usados.

Directiva ROHS

La Directiva sobre Restricciones a la utilización de determinadas Sustancias Peligrosas en Aparatos Eléctricos y Electrónicos (RoHS) entra en vigor el 1 de julio de 2006. A partir de esta fecha, los productores de ciertas categorías de aparatos eléctricos y electrónicos no podrán comercializar productos que contengan seis sustancias prohibidas, a menos que se les apliquen exenciones específicas. Estas sustancias son:

Plomo (Pb), Mercurio (Hg), Cromo hexavalente (Cr(VI)), Cadmio (Cd), pirorretardantes como Polibromobifenilos (PBB) o Polibromodifeniléteres (PBDE).

E/ General conditions

The acceptance of an order by us means, in any case, that the buyer agrees with the following general conditions of Sales and Delivery:

1. Price.

All the prices indicated are recommended and there come without VAT and without ECORAE and there are valid from August 1, 2021 until further notice. Once the commercial invoice is issued, both terms will be applied on it. The prices from the "Tarifa Vigente" make reference to all the products which are located in our warehouses.

We reserve the right to modify the pricing and characteristics of our products, notifying them as soon as possible.

2. Delivery time.

Our delivery time will be immediate, otherwise, in short-term. The delivery time will be met according to our means, but not binding. Those terms are merely informative. The delay in the delivery does not entitle the buyer to cancel the order or to claim any compensation or penalties, unless otherwise agreed by the parties. Even if it was the case, for causes of force majeure, either personally or behalf of third parties, which would lead to a breach in some of the terms agreed, no penalty could be applied.

3. Offers.

The written and oral proposals do not compromise us to accept them immediately. Those offers will be valid once ratified in writing by GRUPO PRILUX ILUMINACION, S.L.U.

4. Transport.

Once the merchandise has been handed to the carrier, the delivery will be considered as proper. The risk of transport is borne by the customer, who only can claim directly to the transport agency, which is in charge of the delivery, for the damage caused during the transport, within less than seven days and in writing and with copy to GRUPO PRILUX ILUMINACION, S.L.U.

5. Claims.

All claims relating to numerical errors and defects will be considered valid only if the claim has already been submitted within the five days from the reception of goods.

6. Returns.

GRUPO PRILUX ILUMINACION S.L.U. does not accept any material returned without its previous consent. These returns have to be forwarded in carriage prepaid with a minimum demerit of 20%. Returns of custom-made products, from campaigns (like christmas) and those ones which do not come in their original packaging and are not in good condition, may not be accepted. In any case, returns of products that exceed 12 months will not be accepted; it is essential to provide the number of the corresponding invoice.

7. Property Rights.

GRUPO PRILUX ILUMINACION S.L.U. keeps, in any case, the full property of all the materials already supplied, until the reciprocal condition of payment is entirely fulfilled.

8. Orders.

Ongoing orders can be cancelled by GRUPO PRILUX ILUMINACION S.L.U., when circumstances of force majeure arise, making impossible to be provided. The orders of custom-made products may not be cancelled by the buyer without our written approval. In case of acceptance by us, the buyer has to cover all the costs caused until the cancellation.

9. Reproduction.

This publication may not be reproduced in whole or in part without GRUPO PRILUX ILUMINACION S.L.U. express authorization.

10. Payment method.

The method of payment will be established when there is a firm order, in accordance with the usual procedure of GRUPO PRILUX ILUMINACION S.L.U.

11. Place of fulfillment and jurisdiction.

Any questions arising in relation to the fulfillment and interpretation of the General Conditions, the contracting parties, expressly relinquish to any other jurisdiction that may be applicable, are subject to the jurisdiction of the Courts and Tribunals of Toledo (Spain).

12. Defective items and warranty.

The guarantee period begins the date of the commercial invoice is issued by GRUPO PRILUX ILUMINACION S.L.U. The liability applies to the materials and manufacturing defects in accordance with the technical standards of each product. The product must be installed in compliance with the current legislation and with the specifications from GRUPO PRILUX ILUMINACION S.L.U. The general guarantee period is one year starting from the date of the commercial invoice, with the exception of the products which, due to its technical characteristics, have a shorter period. The guarantee period includes the number of on/off cycles defined by the IEC standard. After the deadlines above mentioned, any claim, including for damages, will be fully rejected/ excluded.

Christmas products, due to its seasonal character, require usually assembly and dismantling. The handling and its subsequent maintenance are installer's responsibility. GRUPO PRILUX ILUMINACION S.L. does not take any responsibility in case it has not been done properly.

In case of defects, the seller responsibility is limited to the sale price of the defective part of the product. Especially, there is no liability for the repayment in the costs incurred by the buyer or in the product replacement. This applies particularly in the unpacking and in the reinstallation of equipment.

GRUPO PRILUX ILUMINACION, S.L.U. does not assume any responsibility for the damages resulting from the client or third party external to the product. GRUPO PRILUX ILUMINACION, S.L.U. does not take any liability for the alteration and manipulation in any of our products by third parties.

The seller liability is limited in those cases where gross negligence or intention is involved.

The company accepts no responsibility for used products.

RoHS Directive

EU legislation, which restricting the use of hazardous substances in electrical and electronic equipment (RoHS) has been in forced since 1st July 2006. From this date, the producers of certain categories of electrical and electronic devices, may not market those products that contain some forbidden substances, unless some specific exemptions are implemented. Those substances are the following: Lead (Pb), Mercury (Hg), Hexavalent Chromium (Cr(VI)), Cadmium (Cd), Polybrominated biphenyls (PBB), and flame retardants such as Polibromodifeniléteres (PBDE).

F/ Condições gerais

L'acceptation d'une commande par nous signifie, dans tout les cas, que l'acheteur est d'accord avec les suivantes conditions générales de Vente et de Livraison:

- 1. Prix.**

Tous les prix indiqués sont recommandés et ils sont sans TVA et sans ECORAE. Ils sont valables du 1er Août 2021 jusqu'à nouvel ordre. Une fois la facture commerciale est délivrée, les deux termes seront appliqués sur la même. Les prix du "Tarifa Vigente" font référence à tous les produits qui se trouvent dans nos entrepôts.

Nous nous réservons le droit de modifier les prix et les caractéristiques de nos produits, nous vous les notifier le plus tôt possible.
- 2. Délai de livraison.**

Notre délai de livraison sera immédiate, sinon, dans à court-terme. Il sera atteint en fonction de nos moyens, mais non contraignant. Ces délais ont un caractère purement informatif. Des retards dans la livraison ne donnent pas le droit à l'acheteur d'annuler la commande ou de réclamer des indemnités ou des pénalités, sauf d'accord contraire entre les parties. Même si ce fut le cas, les retours de produits qui ont plus de 12 mois, ne seront pas acceptés ; pour compte de tiers, ces qui conduiraient à une rupture de termes convenus, pas de pénalité pouvait être appliqué.
- 3. Offres.**

Les propositions écrites et orales ne nous compromettent pas les accepter immédiatement. Ces offres seront totalement valables une fois qu'ils auront été ratifiés par écrit par GRUPO PRILUX ILUMINACIÓN S.L.U.
- 4. Transport.**

Une fois la marchandise a été remise au transporteur, la livraison sera considérée comme correcte. Le risque du transport est supporté par le client, qui seulement peut réclamer directement à l'agence de transports qui a fait le service, par rapport aux dommages causés lors du transport, dans le période de sept jours et sous écrit et copie à GRUPO PRILUX ILUMINACIÓN S.L.U.
- 5. Réclamations.**

Toutes les réclamations relatives à des erreurs numériques et des défauts, ils seront seulement considérés comme valables, à condition de que la demande a déjà été placée dans les suivants cinq jours après la réception des marchandises.
- 6. Retours.**

GRUPO PRILUX ILUMINACIÓN S.L.U. décline tout matériel retourné sans autorisation précédente. Ces retours doivent être envoyés en port payé avec une pénalité minimum égale à 20%. Les retours de produits sur mesure, des campagnes (comme Noël) et ceux qui ne viennent pas dans leur emballage d'origine et ne sont pas en bon état, ne seront pas acceptés. Dans tous les cas, les retours de produits qui ont plus de 12 mois, ne seront pas acceptés ; c'est essentiel de présenter le numéro de la facture correspondante.
- 7. Droits patrimoniaux.**

GRUPO PRILUX ILUMINACIÓN S.L.U. maintient, en tout cas, la pleine propriété de tous les matériels déjà fournis, jusqu'au moment où la condition de réciprocité de paiement a été complètement rempli.
- 8. Commandes.**

Les commandes en cours peuvent être annulées par GRUPO PRILUX ILUMINACIÓN S.L.U., lorsque les circonstances de force majeure font suite et empêchent les mêmes d'être fournies. Les commandes de produits sur mesure ne peuvent pas être annulées par l'acheteur sans notre autorisation écrite. En cas d'acceptation, l'acheteur doit convenir tous les dépenses occasionnées jusqu'à l'annulation.
- 9. Reproduction.**

Il est strictement interdit de reproduire tout ou partie du présent document sans l'autorisation expresse de GRUPO PRILUX ILUMINACIÓN S.L.U.
- 10. Méthode de paiement.**

Le mode de paiement sera établi lors d'une commande ferme, d'accord avec aux règles habituelles de GRUPO PRILUX ILUMINACIÓN S.L.U.
- 11. Le lieu d'exécution et la juridiction.**

Toutes les questions qui concernent l'exécution et l'interprétation des Conditions Générales, les parties contractantes renoncent expressément à la juridiction que pourrait leur correspondre et se soumettent aux tribunaux de Tolède (Espagne).
- 12. Des articles défectueux et Garantie.**

La période de garantie commence à courir à compter de la date d'émission de la facture commerciale par GRUPO PRILUX ILUMINACIÓN S.L.U. La responsabilité concernant aux matériels et aux défauts de fabrication, elle est en conformité avec les normes techniques de chaque produit. Le produit doit être installé en conformité avec la législation en vigueur et des autres spécifications de GRUPO PRILUX ILUMINACIÓN S.L.U. La période de garanti générale est d'un an à compter de la date d'émission de la facture commerciale, à l'exception des produits qui, en raison de ses caractéristiques techniques, ont une période plus courte. La période de garantie comprend le nombre de cycles d'allumé/éteint définis par la norme CEI. Après les délais mentionnés ci-dessus, toute réclamation, même pour dommages, sera entièrement rejetée/exclue.

Produits de Noël, en raison de son caractère saisonnier, exigent habituellement montage et de démontage. La manipulation et sa maintenance subsequent sont responsabilité de l'installateur. GRUPO PRILUX ILUMINACIÓN S.L.U. ne prend aucune responsabilité au cas où il n'a pas été fait correctement.

En cas de dommages, la responsabilité du vendeur est limitée au prix de vente de la partie défectueuse du produit. Surtout, il n'aura pas de responsabilité pour le remboursement des coûts encourus par l'acheteur ou durant le remplacement du produit. Il s'applique particulièrement dans les cas de réinstallation d'équipement et du déballage.

GRUPO PRILUX ILUMINACIÓN S.L.U. ne prend pas la responsabilité pour les dommages qui viennent du client ou de tiers externes au produit. GRUPO PRILUX ILUMINACIÓN S.L.U. ne prend aucune responsabilité pour la modification et la manipulation de nos produits par des tiers.

La responsabilité du vendeur est limitée dans ces cas où de la négligence grave ou d'intention sont impliqués.

La société décline toute responsabilité pour des produits usés.

Directive RoHS

D'accord avec la législation de l'UE, qui limite l'utilisation de substances dangereuses dans les équipements électriques et électroniques (RoHS) est en vigueur depuis le 1er Juillet 2006. A partir de cette date, les producteurs de certaines catégories de dispositifs électriques et électroniques, ne peuvent pas commercialiser des produits qui contiennent des substances interdites, sauf des dérogations spécifiques sont mises en place. Ces substances sont les suivantes : Plomb (Pb), Mercure (Hg), Chrome Hexavalent (Cr(VI)), Cadmium (Cd), Biphényles Polybromés (PBB) et des retardateurs de flamme comme les Polibromodiphényléthers (PBDE).

P/ Condições gerais

A nossa aceitação de uma encomenda significa, em qualquer caso, que o comprador concorda com as seguintes condições gerais de Venda e Entrega:

- 1. Preço.**

Todos os preços aqui indicados são recomendados e vêm sem IVA e sem ECORAE. Eles são válidos de 1º de agosto de 2021 até novo aviso. Uma vez que a fatura comercial seja emitida, ambos os termos serão acrescentados na mesma. Os preços da "Tarifa Vigente" fazem referência a todos os produtos que estão nos nossos armazéns.

Nós reservamos o direito de modificar os preços e as características das nossos produtos, notifique-os o mais cedo possível.
- 2. Prazo de entrega.**

O nosso prazo de entrega será imediato, caso contrário, em curto prazo. O mesmo será respeitado de acordo os nossos meios, mas não é forçoso. Esses termos são meramente informativos. O atraso na entrega não dá direito ao comprador para cancelar o pedido ou para reclamar qualquer compensação ou penalidades, salvo acordo em contrário das partes. Mesmo neste caso, se existem causas de força maior, pessoais ou por conta de terceiros, o que levaria a uma violação de algum dos termos acordados, nenhuma penalidade pode ser aplicada.
- 3. Ofertas.**

As propostas escritas e orais não nos comprometem a aceitar as mesmas imediatamente. Essas ofertas serão válidas uma vez que tenham sido ratificadas por escrito pelo GRUPO PRILUX ILUMINACIÓN S.L.U.
- 4. Transporte.**

Uma vez que a mercadoria tenha sido entregue ao transportador, a entrega será considerada como correta. O risco de transporte será responsabilidade do cliente, quem só pode reclamar diretamente à agência de transporte, quem faz a entrega, pelos danos causados durante o transporte, em menos de sete dias e por escrito e com cópia para GRUPO PRILUX ILUMINACIÓN S.L.U.
- 5. Requerimentos.**

Todas as reclamações relativas aos erros numéricos e defeitos serão consideradas válidas somente se o requerimento já tinha sido feito dentro do período de cinco dias a contar da recepção das mercadorias.
- 6. Devoluções.**

GRUPO PRILUX ILUMINACIÓN S.L.U. não aceitará qualquer material devolvido sem o seu consentimento prévio. Estas devoluções devem ser feitas em transporte pré-pago e com um demérito mínimo dos 20%. As devoluções de produtos personalizados, das campanhas (como o natal) e aquelas que não venham na sua embalagem original ou venham em mau estado, não serão aceitas. Em qualquer caso, a devolução de produtos que excedam os 12 meses, não pode ser aceite; é essencial proporcionar o número da fatura comercial correspondente.
- 7. Direitos da propriedade.**

GRUPO PRILUX ILUMINACIÓN S.L.U. mantém, em todo caso, a propriedade completa de todos os produtos já fornecidos, até que a condição recíproca de pagamento tenha sido realizada.
- 8. Encomendas.**

As encomendas em curso podem ser canceladas por GRUPO PRILUX ILUMINACIÓN S.L.U., caso surgissem circunstâncias de força maior que impedissem a sua entrega. As encomendas de produtos personalizados não poderão ser canceladas pelo comprador sem a nossa autorização por escrito. No caso da nossa aceitação, o comprador tem de assumir os custos ocasionados até o cancelamento.
- 9. Reprodução.**

Esta publicação não pode ser reproduzida no todo ou em parte, sem a autorização expressa do GRUPO PRILUX ILUMINACIÓN S.L.U.
- 10. Pagamento.**

A forma de pagamento será estabelecida quando a encomenda seja firme, de acordo com as regras usuais de GRUPO PRILUX ILUMINACIÓN S.L.U.
- 11. Local de cumprimento e jurisdição.**

Quaisquer questões que surjam em relação ao cumprimento e à interpretação das Condições Gerais, as partes contratantes, com expressa renúncia ao foro que possa corresponder-lhes, submetem-se à jurisdição dos Tribunais de Toledo (Espanha).
- 12. Material avariado e Garantia.**

O período de garantia terá início na data da emissão da fatura comercial pelo GRUPO PRILUX ILUMINACIÓN S.L.U. A responsabilidade aplica-se aos materiais e defeitos de fabrico em conformidade com as normas técnicas de cada produto. O produto deve ser instalado em conformidade com a legislação vigente e com as especificações do GRUPO PRILUX ILUMINACIÓN S.L.U. O período de garantia geral é de um ano a partir da data da fatura comercial emitida, com exceção dos produtos que, devido a suas características técnicas, têm um período mais curto. O período de garantia inclui o número de ciclos ligado/desligado definidos pela norma IEC. Após os prazos acima referidos, qualquer reclamação, incluindo por danos, será totalmente rejeitada/excluída.

Produtos de Natal, devido ao seu carácter sazonal, requerem normalmente montagem e desmontagem. A manipulação e a sua posterior manutenção são responsabilidade do instalador. GRUPO PRILUX ILUMINACIÓN S.L.U. não assume qualquer responsabilidade no caso de não ter sido feito corretamente.

Em caso de defeitos, a responsabilidade do vendedor será limitada ao preço de venda da parte defeituosa do produto. Especialmente, não tem responsabilidade nenhuma para o reembolso dos custos suportados pelo comprador ou por substituição de produto. Aplica-se especialmente no caso de desempacotamento e em reinstalações do equipamento.

GRUPO PRILUX ILUMINACIÓN S.L.U. não assume a responsabilidade pelos danos feitos pelo cliente ou um terceiro externo ao produto. GRUPO PRILUX ILUMINACIÓN S.L.U. não assume nenhuma responsabilidade pela alteração ou manipulação feita por terceiros nos nossos produtos.

A responsabilidade do vendedor é limitada nos casos em que existisse negligência ou dolo. A empresa declina qualquer responsabilidade no caso de produtos já usados.

Diretiva RoHS

De acordo com a legislação europeia, aquela que restringe o uso de substância perigosas em equipamentos elétricos e eletrônicos (RoHS), em vigor desde 1 Julho de 2006. A partir desta data, os produtores de certas categorias de equipamentos elétricos e eletrônicos, não podem comercializar produtos que contêm substâncias proibidas, a menos que alguma isenções específica sejam implementadas. Essas substâncias são: Chumbo (Pb), Mercúrio (Hg), Cromo Hexavalente (Cr(VI)), Cádmio (Cd), Bifenilos Polibromados (PBB) e outros retardadores de chama como os Polibromodifeniléteres (PBDE).



Descarga/Download/Télécharger/Baixar



Leyenda/ Legend/ Légende/ Lenda

GRUPO PRILUX ILUMINACIÓN S.L.U.

SEDE CENTRAL

C/ Río Jarama nº 149.45007, Toledo (Spain).
Tel.: (+34) 925 23 38 12 / Fax: (+34) 925 23 38 80

DELEGACIÓN NORESTE

Carretera BV - 2249 Km 8
08791, Sant Llorenç d'Hortons, Barcelona (Spain).
Prilux eConcept Tel.: (+34) 93 891 37 24
Grupo Prilux Iluminación S.L.U Tel: (+34) 93 719 23 29

www.grupoprilux.com

IMPRESIÓN

Agosto 2021

DISEÑO GRÁFICO

Departamento de Marketing

Pueden aparecer variaciones con respecto al color original debido a causas técnicas de la impresión.

Este catálogo actualiza los valores y características de las mismas luminarias que aparezcan en anteriores catálogos.

Los datos incluidos en este catálogo son correctos salvo error tipográfico.

Grupo Prilux Iluminación S.L.U. se reserva el derecho a cualquier modificación del producto sin previo aviso.

Web



#led's **PLAY!**

www.grupoprilux.com

